

LC101

Z METER

CAPACITOR — INDUCTOR ANALYZER

Operation, Application, and Maintenance Manual

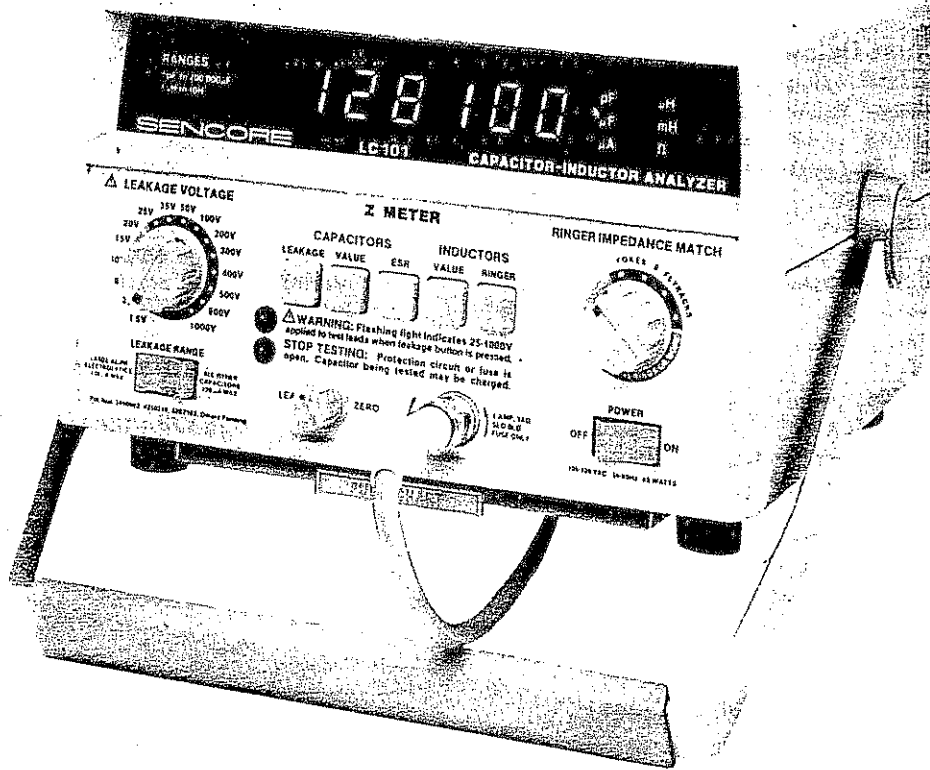

SENCORE

3200 Sencore Drive, Sioux Falls, South Dakota 57107

TABLE OF CONTENTS

SAFETY PRECAUTIONS	Inside Front Cover	
SIMPLIFIED OPERATIONS		4
DESCRIPTION		
Introduction.....		6
Features.....		6
Specifications.....		6
Controls.....		8
Supplied Accessories.....		10
Optional Accessories.....		10
OPERATION		
Introduction.....		12
Power Connection.....		12
Stop Testing Alarm.....		12
Fuse Replacement.....		12
Test Leads.....		13
Test Lead Mounting Clip.....		13
CAPACITOR TESTING		
Capacity Measurement Accuracy.....		13
Lead Zero.....		14
Checking Capacitors Below 2 pF.....		14
Interpreting Z METER Value Readings.....		15
Testing Large Screw Terminal Lytics.....		15
Checking Capacitors for Leakage.....		15
Ceramic, Paper, Mica, and Film Types.....		16
Aluminum Lytics.....		16
Tantalum Lytics.....		17
Leakage Charts.....		17-18
Identifying Capacitor Types.....		18
Tantalum Lytics.....		19
Ceramic Discs.....		19
Film Types.....		19
Testing for Dielectric Absorption.....		19
Reforming Lytics on the Z METER.....		20
Reforming Lytics with a Power Supply.....		21
Checking Capacitors for ESR.....		21
ESR Charts.....		22
To Eliminate Test Lead Resistance.....		23
Capacitor Testing Application Tips		
No Value Reading on Small Value Capacitors.....		23
Leakage in Ceramic, Paper, Film, and Mica Capacitors.....		23
Dielectric Stress.....		24
Checking for Leakage Between Sections of a Multi-Section Lytic.....		24
Large Fluctuations in Lytic Leakage Readings.....		24
Leakage Measurements of Non-Polarized Lytics.....		24
Lytics Sitting in Stock.....		25
Intermittent Capacitors.....		25
Time Required to Obtain a Value Reading on a Capacitor.....		25
Checking Ceramic Capacitors for Temperature Sensitivity.....		25
Testing Capacity of Silicon Diodes and Transistors.....		25
Testing High Voltage Diodes.....		26
Testing Silicon Controlled Rectifiers (SCRs) and TRIACs (with optional SCR250).....		26
Determining the Length of RF Coaxial Cable.....		27
How to Find a Short in a Coaxial Cable.....		28
How to Determine Inductance or Capacitance Per Foot of Coaxial Cable.....		28
INDUCTOR TESTING		
Checking Inductors for Inductance Value.....		28
Balancing Out Lead Inductance.....		29
Checking Coils Below 2 Microhenrys.....		29
Open Winding in a Coil.....		29
Checking Inductance In-Circuit.....		29
Testing Inductors on Printed Circuit Boards.....		30
Mutual Inductance.....		30
Inductor Coding.....		30
Checking Inductors for Good or Bad With The Ringing Test.....		31
Inductor Testing Application Tips		
Peaking Coils.....		32
Coils in Metal Shields.....		32
Ferrite Core Transformers and Coils.....		33
Testing Flyback Transformers With The Ringing Test.....		33
Testing Yokes With the Ringing Test.....		34

MAINTENANCE

Introduction..... 36
Recalibration & Service..... 36
Circuit Description & Calibration Procedures.... 36
Replacement Leads..... 36
220VAC Operation..... 36
Zeroing Adjustments..... 36

APPENDIX

Capacitor Theory and the Z METER..... 38
Capacitor Color Code and Marking Charts..... 42
Glossary of Terms..... 46

SERVICE AND WARRANTY..... Inside Back Cover

SIMPLIFIED OPERATIONS

CAPACITOR TESTS

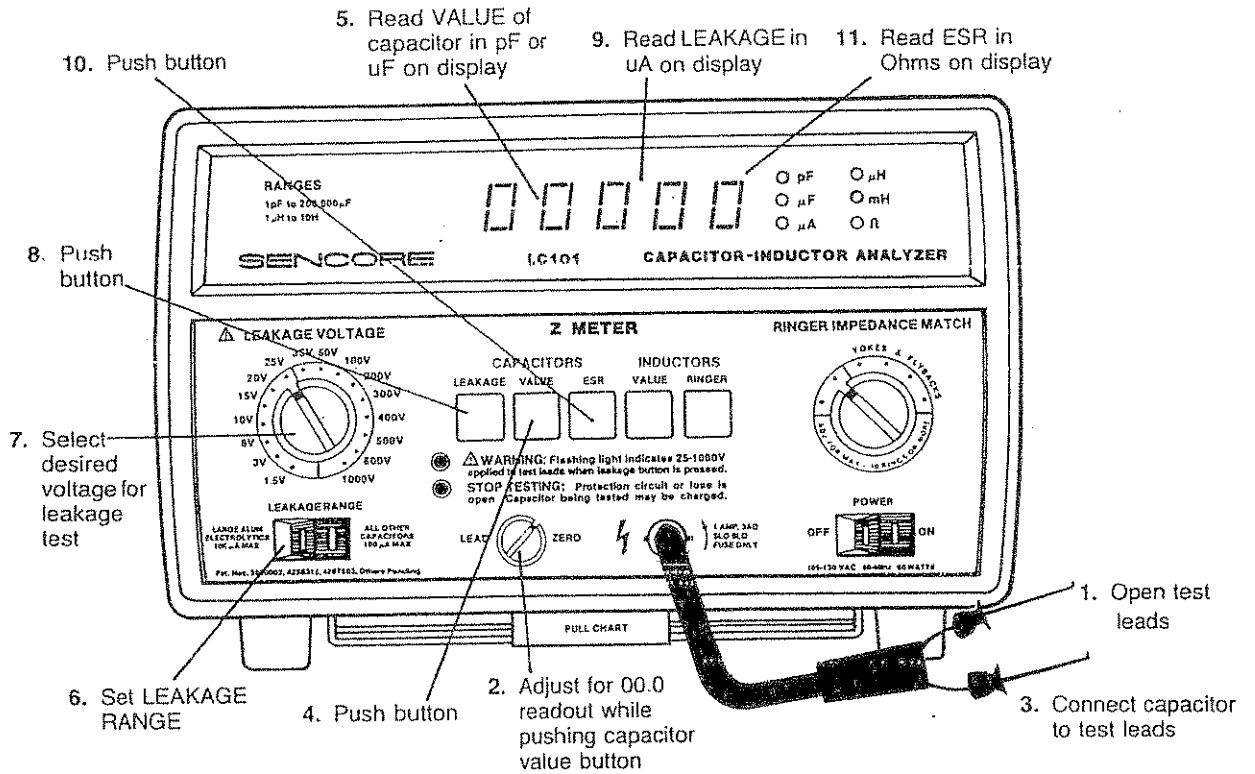

INDUCTOR TESTS

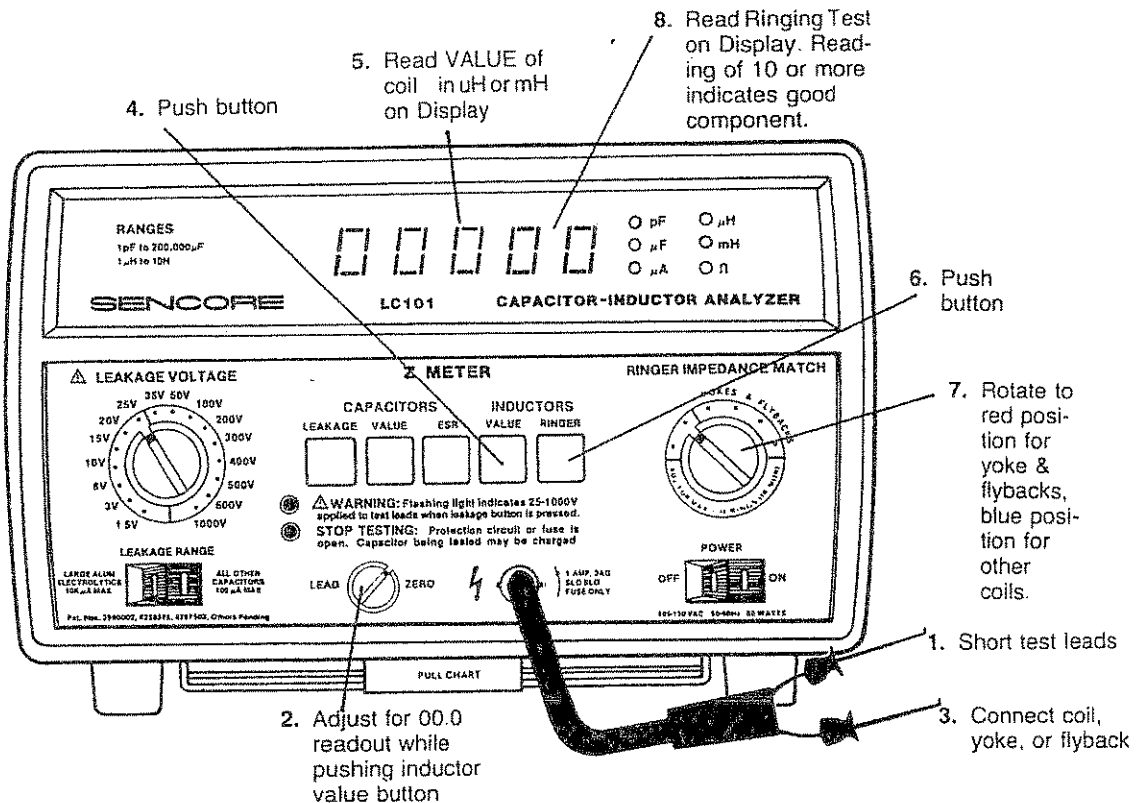

Notes

DESCRIPTION

Introduction

Capacitor and inductor usage in electronic equipment is increasing rapidly and the forecast is for this growth to continue. Much of the increased use of capacitors and inductors is due to the increasing use of the integrated circuit. ICs are taking the place of discrete components in many electronic circuits. Due to their construction however, capacitors and inductors are not contained within the IC package, but rather remain as discrete components. To meet the requirements of today's IC circuits, capacitors and inductors have tighter tolerance and more critical parameters than ever before. As the use of ICs increases, so will the usage of capacitor and inductors. The need to measure critical capacitor parameters and inductor value and quality is greater than ever before. Without a good reliable measurement of these parameters, circuit troubleshooting becomes difficult. The Sencore LC101 Z METER meets this challenge. It allows capacitors to be checked for value, ESR and leakage at their rated working voltage. The LC101 also provides a patented dielectric absorption test. Inductors are readily tested for value with a patented inductance test and for quality with a patented ringing test. The LC101 is a complete capacitor and inductor analyzer.

Features

The Sencore LC101 Z METER is a complete, capacitor and inductor analyzer (4 patents) designed to locate defective components. Simply hook the capacitor or inductor to the test leads, push a button and the LC101 automatically displays the value on the digital readout.

In addition to checking value, the LC101 also checks capacitors for leakage at their rated working voltage from 1.5 to 1000 volts. A flashing LED serves as a safety reminder when the voltage applied to the capacitor is 35 volts or higher. A patented dielectric absorption test and patented ESR test round out the capacitor checks, making the LC101 a unique, thorough capacitor analyzer.

The Sencore patented inductance value test provides a fast, reliable check of true inductance. The Sencore patented ringing test checks coils, deflection yokes, and other non-iron core transformers with an accurate good/bad check. Six impedance matching settings match coils from 10uH to 10H to the test circuit. Good coils show 10 or more ringing cycles on the digital display while bad coils show less than 10.

A LEAD ZERO control allows you to balance out test lead capacity and inductance for accurate readings of very small capacitors and coils. The Z METER is protected against accidentally being applied to the test leads by a front panel, replaceable fuse and a special relay inside the instrument.

Specifications

Digital Readout

TYPE: .5", 7 segment LED.

ACCURACY: Function accuracy + resolution error.

RESOLUTION: 3 significant digits +/- 2 counts on 3rd digit (3 1/2 digits on capacitors of 100,000 uF to 200,000 uF).

AUTORANGING: Fully automatic decimal placement. One or two place holding zeros added as needed (does not affect accuracy) to provide standard value readouts of uF, pF, uH, or mH.

RANGE INDICATORS: Type: LED

Operation: Controlled by the autoranging circuits.

Capacitors (Out Of Circuit):

Dynamic test of capacity value determined by measuring one RC time constant when capacitor is charged to +5V through:

10 Megohms for 0-9000 pF. 10 Kilohms for 9000 pF-90 uF. Values greater than 90 uF are charged with a constant current of 60 mA.

ACCURACY: +/- 1% of reading + resolution error, +/- 1 +/-5% of reading + resolution error for caps over 1000uF.

RANGE: 1.0 pF to 199,900 uF in 10 automatically selected ranges.

Capacitor Leakage

ACCURACY: +/-5% + resolution error.

RANGES: 0 to 99.9 uA and 0 to 9.99K uA in two switch selectable ranges.

VOLTAGES: 16 selectable DC voltages from 1.5 VDC to 10 VDC filtered, and from 15 VDC to 1000 VDC, non-filtered. Available at test leads only when LEAKAGE pushbutton is depressed. Capacitor is automatically discharged when button is released.

Capacitor ESR (U.S. Patent 4,795,966)

ACCURACY: +/-5% + resolution error.

RANGE: 0.10 Ohm to 999 Ohms in 3 automatically selected ranges.

CAPACITOR RANGE: 1uF minimum value for specified accuracy.

Capacitor D/A

Dynamic test of capacitor dielectric absorption determined by the difference in capacity value measured before and after applying rated voltage to the capacitor (US patent 4,267,503).

APPLIED VOLTAGE: Same as capacitor leakage.

ACCURACY: Same as capacitor value accuracy.

Inductance (In-or-Out-of-Circuit)

Dynamic test of inductance value determined by measuring the EMF caused by a constantly varying current through the coil under test (US patent 4,258,315). Current rates are:

10 mA/usec - 0 to 90 uH.
1 mA/usec - 90 to 900 uH.
.1 mA/usec - 900 uH to 9 mH.
.01 mA/usec - 9 to 90 mH.
1 uA/usec - 90 to 900 mH.
.1 uA/usec - 900 to 9,990 mH.

ACCURACY: $\pm 2\%$ of reading + resolution error.
RANGES: 1.0 uH to 9,990 mH in 6 automatically selected ranges.

Ringling Test

Dynamic test of inductor quality determined by counting the number of cycles the inductor rings before reaching a preset damping point after a given exciting pulse has been applied. (US patent 3,990,002)

EXCITING PULSE AMPLITUDE: Approximately 7 Volts peak.
ACCURACY: ± 1 count from readings of 8 to 13.

Accessories (Supplied)

39G219 Test Leads
39G144 Test Lead Adaptor
39G201 Test Button Hold Down Rod
64G37 Test Lead Mounting Clip
68G34 Allen Wrench
44G20 Spare 1 Amp Slo-Blo Fuse

Accessories (Optional)

39G85 Touch Test Probe
FC221 Field Calibrator
SCR250 SCR/TRIAC Test Accessory

General

TEMPERATURE RANGES (Typical): Calibrated at 70 degrees F. Rated accuracy range: 50-90 degrees F. Operating range: 32-130 degrees F. POWER: 105-130 VAC, 60 Hz, 25 Watts.
TEST LEAD INPUT: Fuse protected with in-line 1 Amp 3AG Slo Blo fuse.
SIZE: 6" x 9" x 11.5" (15.24 cm x 22.86 x 29.21 cm)
WEIGHT: 7.75 lbs. (3.56 Kg).

Specifications subject to change without notice.

Controls

1. **DIGITAL READOUT** - First three digits read the value of capacity, inductance, leakage current or ringing test values, last two digits are place holders and only indicate 0 on larger values of capacity, inductance, or leakage current so all readings are given as pF, uF, uH, or mH.

2. **INDICATOR LEDs** a. pF - lights up when capacitor reading is in picofarads. b. uF - lights up when capacitor reading is in microfarads. c. uA - lights up when capacitor leakage reading is in microamps. d. uH - lights up when inductor reading is microhenrys. e. mH - lights up when inductor reading is in millihenrys. f. OHM - lights up when ESR reading is in Ohms

3. **IMPEDANCE MATCH SWITCH** - Rotate through the last 4 test positions to make the ringing test on yokes and flybacks and through all 6 positions when testing other inductors. A reading of 10 or more indicates a good inductor.

4. **POWER SWITCH** - Controls the AC line voltage to the Z METER.

5. **RINGING TEST** - Depress to make the patented Sencore ringing test on inductors, yokes, and flybacks to check the quality. Use **IMPEDANCE MATCH** switch (3).

6. **INDUCTOR VALUE** - Depress to test inductors for value of inductance.

7. **TEST LEAD INPUT JACK** - Unscrew jack for access to input protection fuse.

8. **ESR TEST** - Depress to test capacitors for ESR.

9. **CAPACITOR VALUE** - Depress to test capacitors for capacity value.

10. **PULL CHART** - Provides simplified operating instructions and quick reference tables for capacitor leakage and ESR.

11. **LEAD ZERO** - Use to balance out capacity or inductance in the test leads when measuring small values of capacitors or inductors.

12. **LEAKAGE TEST** - Depress to test capacitors for leakage after the **LEAKAGE VOLTAGE** switch (15) has been set to the working voltage of the capacitor and **LEAKAGE RANGE** switch (14) is set to the proper value as indicated in the leakage chart (10).

13A. **CAUTION INDICATOR LED** - Blinks when the **LEAKAGE VOLTAGE** switch(15) is set to 35 Volts or higher as a warning to the user. Voltage is only present on test leads when **LEAKAGE** button (12) is depressed.

13B. **PROTECTION CIRCUIT OR FUSE OPEN ALARM** - A flashing LED along with an audible alarm will activate when either the test lead input fuse opens or the protection circuit senses 7.5 volts or greater.

14. **LEAKAGE RANGE SWITCH** - Use to select the desired range of capacitor leakage current, 0 to 100 uA or 10K uA.

15. **APPLIED VOLTAGE SWITCH** - Use to select the desired test voltage when making capacitor leakage tests.

Rear Panel

16. 39G201 Test Button Hold Down Rod mounting clip.

17. 39G144 Test Lead Adaptor mounting clip.

18. Rear panel **METER ZERO** adjust Adjust to zero digital readout with all buttons out.

19. Rear Panel **CAPACITOR ZERO** Adjust to zero digital readout with test leads open and capacitor value button depressed.

20. Rear Panel **ESR ZERO** - Adjust to Zero digital readout with test leads shorted and capacitor ESR button depressed.

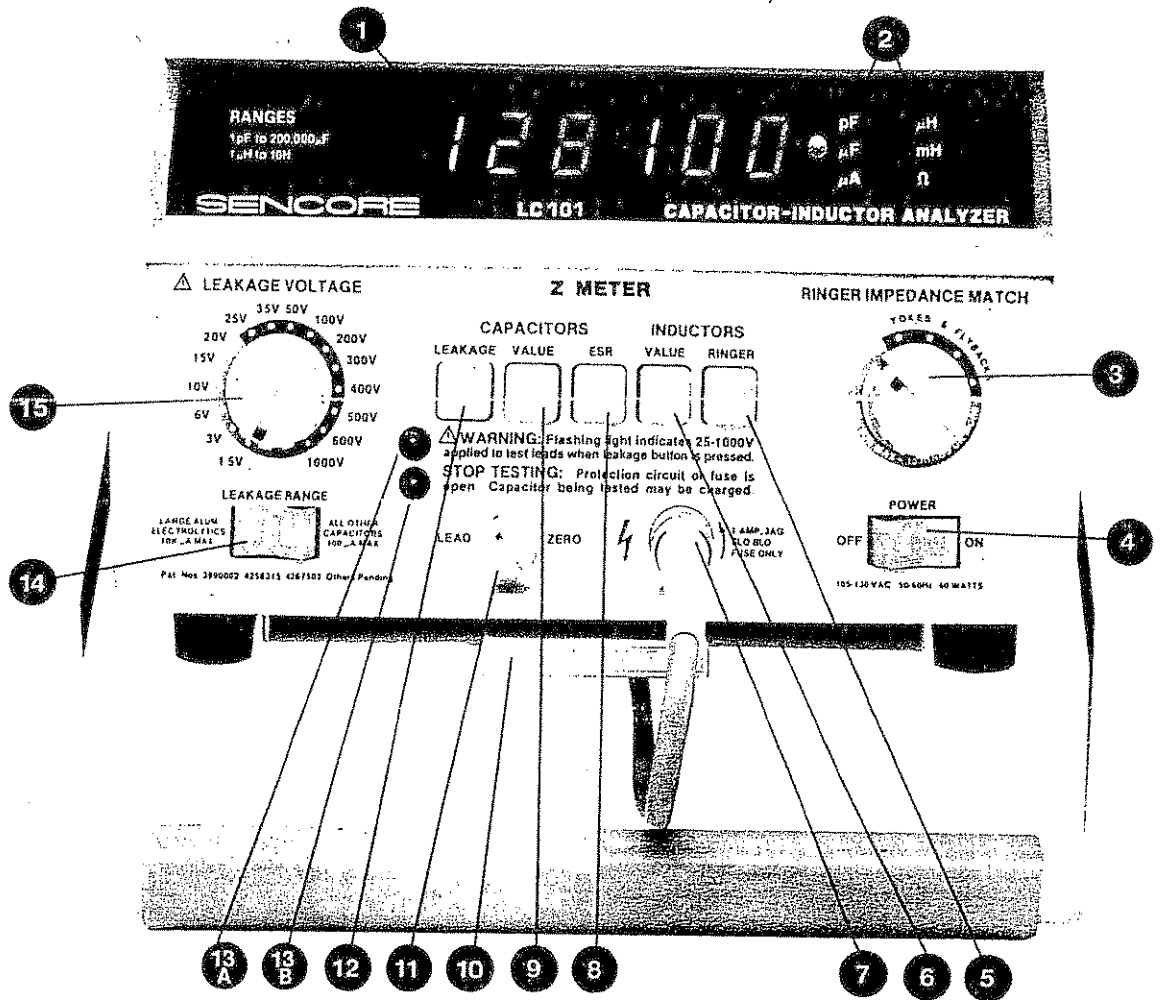

Fig. 1: Location of LC101 front panel controls and features.

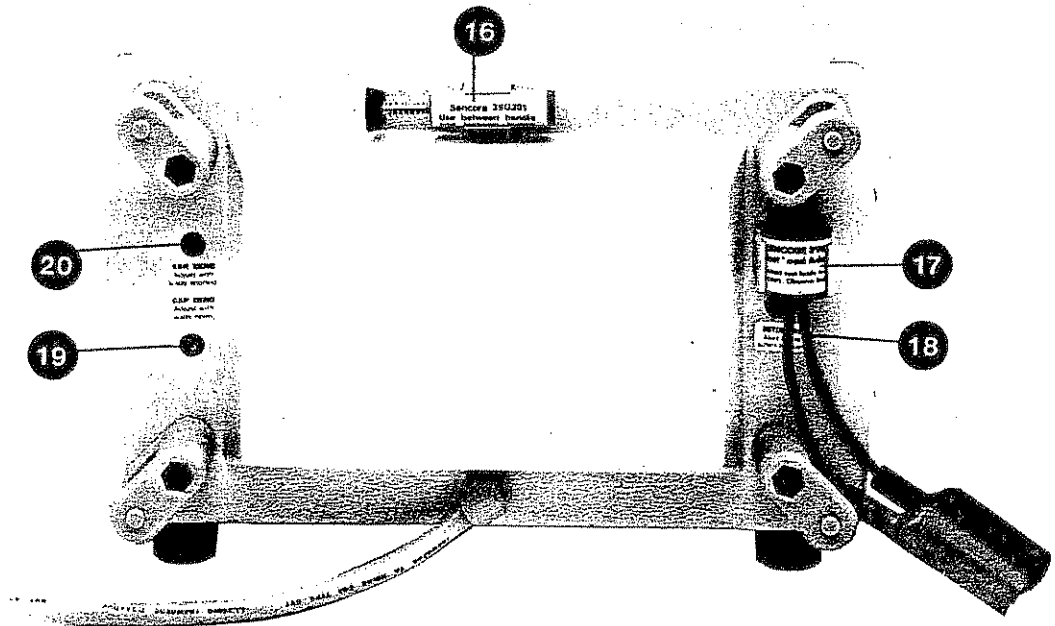

Fig. 2: Location of LC101 rear panel controls and features.

Supplied Accessories

21. 39G201 TEST BUTTON HOLD DOWN ROD - Use to hold LEAKAGE (12) button depressed when reforming capacitors.
22. 39G144 TEST LEAD ADAPTOR - Use to adapt test lead (23) clips to large screw terminal capacitors.
23. 39G219 TEST LEADS - Special low capacity cable with E-Z Hook clips. Connect to Test Lead Input Jack (7).
24. 64G37 TEST LEAD MOUNTING CLIP Use to hold Test Lead when not in use.
25. 68G34 ALLEN WRENCH - Used to tighten knobs.
26. 44G20 SPARE FUSE - 1 Amp, Slo Blo replacement for fuse in Test Lead Input Jack (7).

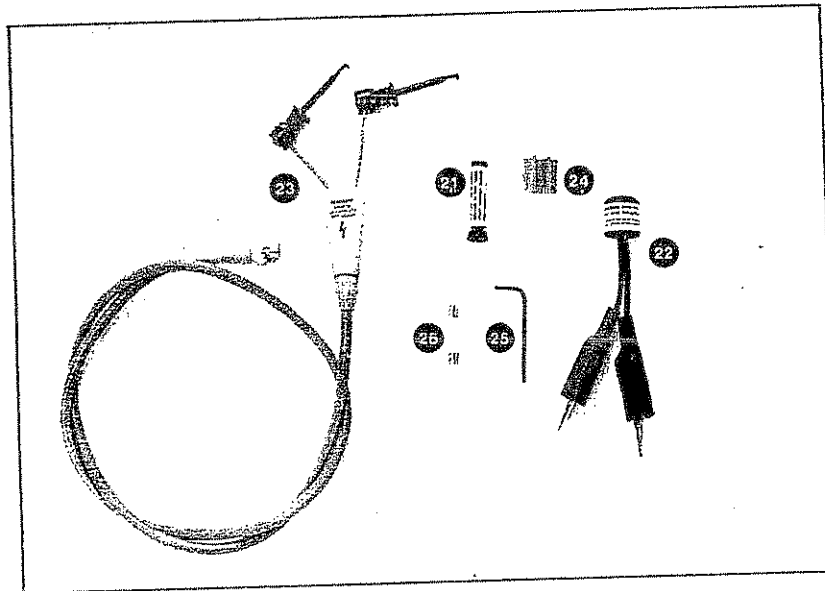

Fig. 3: Supplied Accessories.

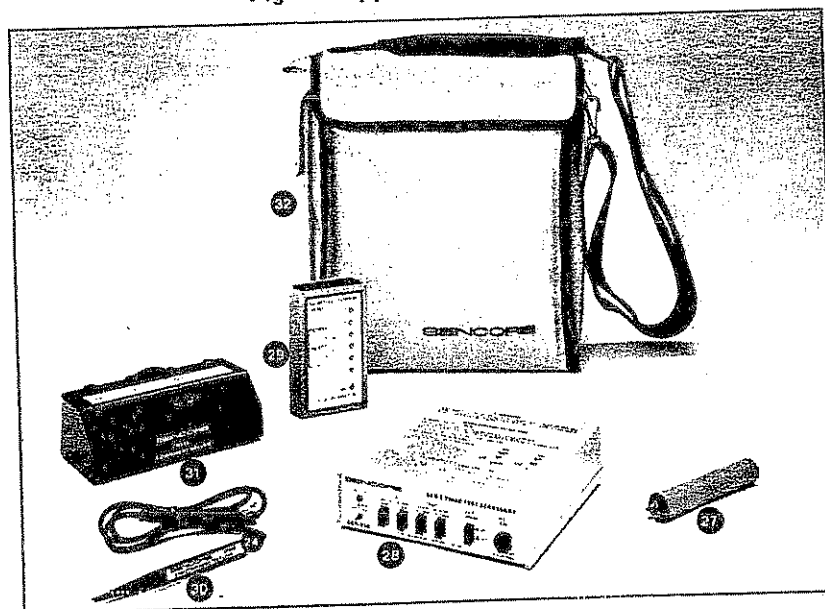

Fig. 4: Optional Accessories.

Optional Accessories

27. 39G85 TOUCH TEST PROBE - Use for in-circuit testing of coils from foil side of P.C. board.
28. SCR250 SCR AND TRIAC TEST ACCESSORY - Use for testing SCRs and TRIACS.
29. FC221 FIELD CALIBRATOR - Use to periodically check calibration of LC101.
30. CH256 CHIP COMPONENT TEST LEAD Substitutes for the 39G219 Test Leads for testing small chip capacitors and inductors.
31. CH255 COMPONENT HOLDER Substitutes for the 39G219 when testing radial and axial lead components.
32. CC254 CARRYING CASE- Provides protection and easy carrying for the LC101 and its accessories.

Notes

OPERATION

Introduction

Before using your LC101 Z METER for the first time, take a few minutes to read through the operations and applications section of the manual carefully to acquaint yourself with the features of the LC101. Once you are familiar with the general operations, most tests can be performed with the information provided on the LC101 front panel.

Power Connection

The LC101 is designed to be operated from 105-130 VAC (50/60 Hz). If 210-230 VAC operation is required, the unit may be modified (at additional cost) by the Sencore Service Department, 3200 Sencore Drive, Sioux Falls, SD 57107.

To operate the LC101 from the AC line:

1. Connect the AC line cord to a 117 VAC (or 220 VAC for modified units) outlet.
2. Turn the power switch on.
3. The LC101 is immediately ready to make capacitor or inductor checks. If precise measurements are to be made, the unit should be allowed to operate for at least 5 minutes to allow the circuits to stabilize.

Stop Testing Indication

The LC101 is designed to provide you with the safest possible method of testing capacitors and inductors. The STOP TESTING indicators of the LC101 are a flashing LED indicator on the front panel and an internal audible alarm. This important feature alerts you when a shock potential exists due to either the test lead fuse having blown, preventing the capacitor from discharging, or that you have connected to a charged circuit.

If the STOP TESTING indicators activate:

1. Stop all testing with the LC101.
2. Carefully discharge the capacitor you are testing by connecting a 10K ohm 1 watt resistor across the terminals.
3. Replace the test lead fuse if blown, or remove the voltage from the point the test leads are connected to.
4. Resume testing.

Fuse Replacement

AC FUSE: The LC101 does not use an AC line fuse. Instead the unit is protected by a special thermal switch in the power transformer. If the power transformer is overloaded, the thermal switch opens

the primary, removing the voltage from the unit. Simply allow the unit to cool down and the thermal switch will close, applying power to the primary and allowing the unit to operate again.

TEST LEAD FUSE: A 1 Amp, 3 AG, Slo Blo fuse is used in the test lead input on the Z METER. This protects the the unit from voltage accidentally applied to the input. Replace with a 1 Amp, 3AG, Slo Blo type only.

WARNING

Always replace the fuse in the test lead with a 1 Amp, 3AG, Slo Blo type. Any other type or current rating may cause internal damage to the unit and will void all warranties.

TEST LEAD INPUT FUSE REPLACEMENT: The fuse for the test lead input is located behind the BNC input jack. Remove the fuse holder by turning the BNC connector counter clockwise and unscrewing the connector until the fuse is free. The BNC connector of the test leads may be used as a "Wrench" to aid in the removal of the fuse holder. When replacing the fuse holder, make sure it is screwed in tightly to prevent the connector from turning when connecting and disconnecting test leads. Replace the fuse with a 1 Amp Slo Blo 3AG fuse only.

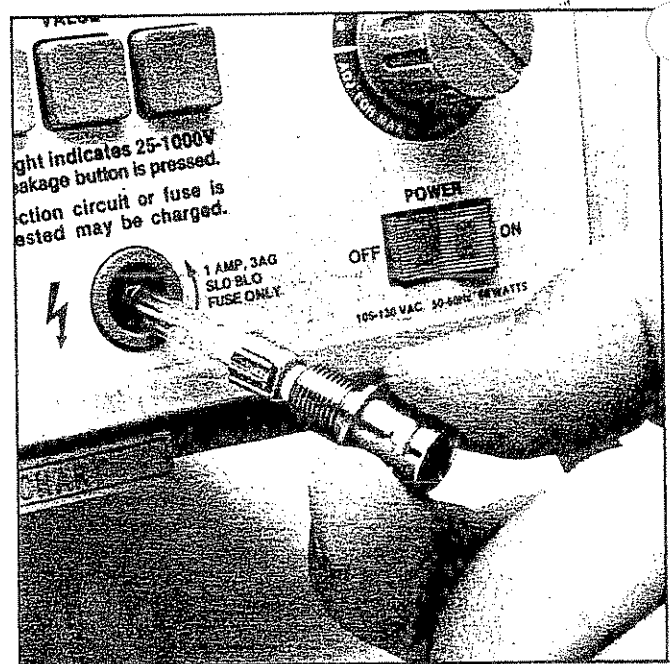

Fig. 5: A 1 amp 3AG Slo Blo fuse protects the LC101 input. The fuse is located behind the test lead input jack.

Test Leads

39G219 TEST LEADS: The test leads (supplied with the LC101) use a special low capacity cable. Using any other cable adds extra capacity to the meter circuit which may be out of range of the LEAD ZERO control. If the test leads ever need replacing, order new leads (39G219) directly from the Sencore Service Department, 3200 Sencore Drive, Sioux Falls, SD 57107.

Test Lead Mounting Clip

The Special Test Lead Mounting Clip (64G37) may be mounted on the top of the Z METER, on the side of the handle, or on your work bench. The clip holds the test leads out of the way, but keeps them ready for use at any time. To mount the test lead clip, simply peel off the backing, place on the spot to be mounted, and press firmly.

NOTE: Do not mount the Test Lead Clip to the sides of the Z METER as it will interfere with the movement of the handle.

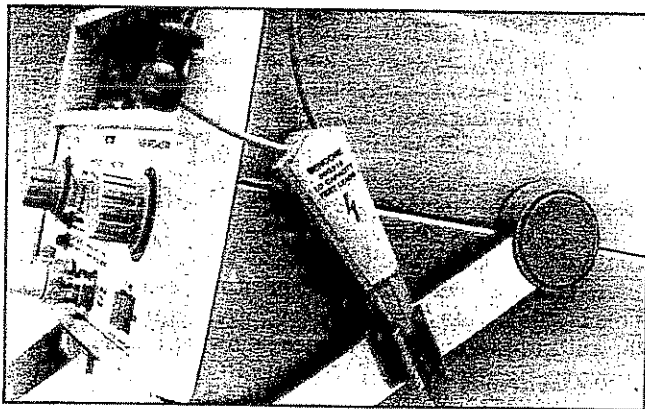

Fig. 6: The test lead mounting clip holds the test leads out of the way, but ready for use.

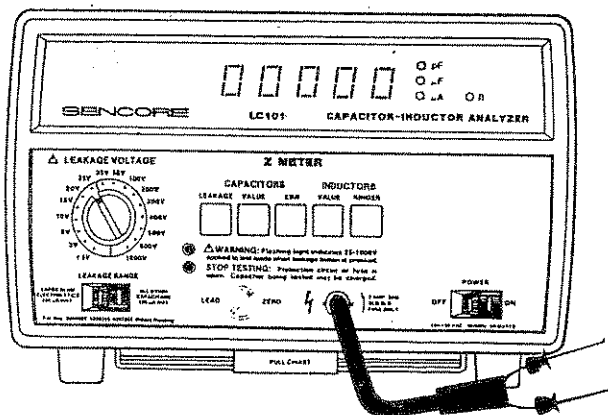

Fig. 7— Controls used for capacitor testing

Capacitor Testing

The Z METER checks capacitors for their actual capacity with 6 automatically selected ranges. Simply

connect the capacitor to the test leads, push the VALUE button under CAPACITORS and read the value on the digital readout.

SPECIAL NOTES ON CAPACITOR TESTING:

1. Only power the Z METER through a properly grounded AC outlet. The third wire ground on the Z METER provides more accurate readings of low level capacitors (below 1000 pF) with the third wire shielding. Defeating the third wire ground results in lower accuracy value readings on capacitors below 1000 pF and voids the warranty. If grounded outlet is unavailable, use a grounding adaptor and connect the third wire to a good earth ground such as a water pipe.
2. The Z METER has been designed to give accurate readings of capacitor value out of circuit. Impedances found in the circuit will upset the Z METER readings. Capacitors cannot be checked in circuit with any degree of accuracy or reliability with any known test method.
3. Remove the power from the circuit if a capacitor is to be checked that has one end removed but the other end still connected to the circuit. If the unit under test is AC operated, remove the AC line cord from the AC outlet. Whenever possible, remove the capacitor completely from the circuit.

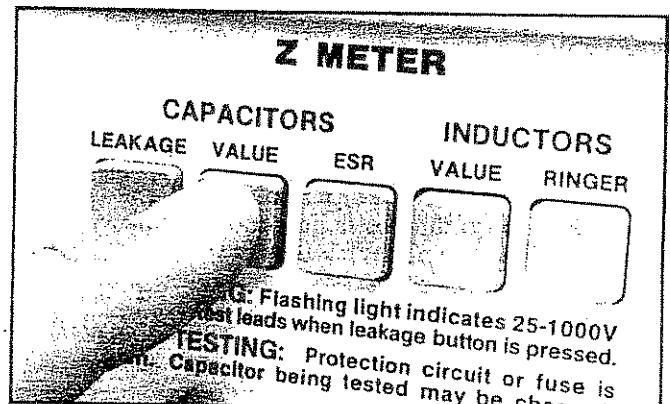

Fig. 8: To measure capacity, connect the capacitor to the test leads, depress the VALUE button, and read the amount of capacitance on the digital display.

Capacity Measurement Accuracy

The Sencore Z METER has been designed to provide accurate measurements (within 1% of reading) of capacity using the most accurate method available. The Z METER measures the RC charging time of the capacitor with a precision charging resistor. This gives a true and accurate capacity measurement. The readings of the Z METER may or may not be the same as those of another instrument using a different measuring system. The bridge, for example, uses an AC signal and measures capacitive reactance, not the actual capacity. Two bridges with different frequency signals will give different capacity readings because the capacitive reactance changes with frequency. The higher the frequency, the lower the capacitive reactance and the lower the capacity reading. The

Sencore Z METER will provide a true measure of capacity.

It is normal for electrolytic capacitors to read up to 50% higher than their marked value. The reason is that electrolytics are marked according to the value measured on an AC-type impedance bridge. The diode action of the capacitor causes the current waveform to be restricted, causing the bridge to measure the value lower than its true capacity value.

This should cause no trouble in determining whether an electrolytic is good, as most electrolytics have a 50 to 80% tolerance. The capacitor should read its marked value or higher on the LC101. Most electrolytics fail due to leakage or dielectric absorption rather than value change. Value changes that do take place result in a value drop far below the marked value.

WARNING

When checking capacitors, connect the capacitor to the test leads before depressing the VALUE or LEAKAGE bushbutton.

To Check Capacitors for Capacity Value

1. Connect the test leads to the capacitor to be tested. Polarity of the test leads is only important if checking a polarized capacitor. When checking polarized capacitors the red test lead must be connected to the positive capacitor terminal.

2. Depress the CAPACITOR VALUE Pushbutton.

3. Read the value of the capacitor on the display. The value of capacity will be in microfarads if the LED in front of the μF indicator is lit, or in picofarads if the LED in front of the pF indicator is lit.

NOTE: Most capacitor values read very quickly, but extremely large electrolytic capacitors (over 50,000 μF) may take a few seconds to display a reading. For example, a 50,000 μF cap will take about 5 seconds before a reading is seen on the digital readout and a 100,000 μF electrolytic may take 10 seconds. If the value does not read in the time listed above, the capacitor is either shorted or very leaky. In either case, it is probably defective.

Lead Zero

Small value capacitance readings (2 pF to 1000 pF) may be off slightly due to the capacity of the test leads. This capacity can be balanced out with the LEAD ZERO control. The LEAD ZERO control is automatically switched out of circuit for capacity values above 10,000 pF.

To Eliminate Test Lead Capacity:

1. Place the test leads (with no capacitor connected) on the work area so that they will not be moved when the capacitor is connected. Be sure that the test leads are not on a metal surface or near an AC power outlet or

AC operated device. Stray AC may affect the reading of small values of capacitors.

2. Depress the VALUE button and adjust the LEAD ZERO control until the meter reads 00.0, with negative sign appearing occasionally.

3. Carefully connect the capacitor to be tested to the test leads. Depress the VALUE button and read the actual value of the capacitor on the meter.

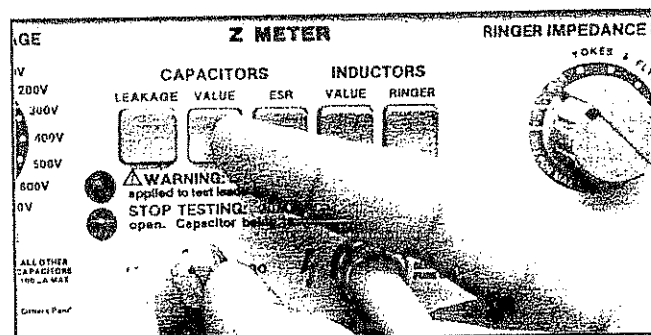

Fig. 9: Zero out the test lead capacity when measuring small value capacitors.

One the LEAD ZERO control has been set it should not need to be readjusted for ESR or Inductance lead zeroing. If the control must be reset, refer to the section "Zeroing Adjustments" on page 36 of the MAINTENANCE section.

Checking Capacitors Below 2 Picofarads

The autoranging circuit in the Z METER will often show a "00.0" readout for capacitors less than 2 pF. This is due to the "zero window" that is necessary for the autoranging circuit. Values below 2 pF can be read, however, by using the LEAD ZERO control to offset the meter zero.

To Read Capacitors Less Than 2 pF

1. Place the test leads (with no capacitor connected) so that they will not be moved when the capacitor to be tested is connected. Be sure that the test leads are not on a metal surface or near AC power or an AC operated device.

2. Depress the VALUE button and adjust the LEAD ZERO control until the meter reads a positive number such as 2.0 pF. A negative number can be obtained on the readout but will give an incorrect reading.

3. Connect the capacitor to the test leads without disturbing their position on the work area.

4. Depress the VALUE button to obtain a reading on the meter. Subtract the setting of step 2 from the reading to get the actual value of the capacitor. For example, if the reading obtained was 2.6 and the setting in step 2 was 2.0, then the capacitor value is 2.6 minus 2.0 or 0.6 pF.

Interpreting Z METER Value Readings

Some capacitor defects result in a reading much lower than the tolerance specified for the capacitor. Details on determining the tolerance of common capacitors are included in the Appendix section at the end of the manual. If the reading is outside this tolerance, the capacitor should be considered bad.

Some capacitors, especially aluminum electrolytics, may show an overrange indication (flashing 888). This reading indicates that the capacitor is defective.

The LC101 automatically displays the two most common capacitor values of picofarads (pF) and microfarads (uF). Capacitors from 1 pF to .089 uF will show as "pF", and capacitors over .09 uF will show as "uF". You may encounter some capacitors that are marked with the opposite multiplier. Some companies, for example, will mark the value of a given capacitor as ".047 uF", while others may make the same type of capacitor as "4700 pF". The following table will explain how to easily convert one reading to another.

CHANGE TO FROM	MICROFARADS	NANOFARADS	PICOFARADS
MICROFARADS		Move decimal 3 places right	Move decimal 6 places right
NANOFARADS	Move decimal 3 places left		Move decimal 3 places right
PICOFARADS	Move decimal 6 places left	Move decimal 3 places left	

Table 1— Capacitor multiplier conversion chart

Testing Large Screw Terminal Lytics

Some electrolytics, especially in industrial applications, use rather large screw terminals rather than the conventional solder terminals. The 39G144 TEST LEAD Adaptor (supplied with the LC101) should be used to convert the small E-Z Hook® clips to large alligator clips to fit the large screw terminals. A special clip is mounted on the back of the LC101 to store the 39G144 when it's not in use.

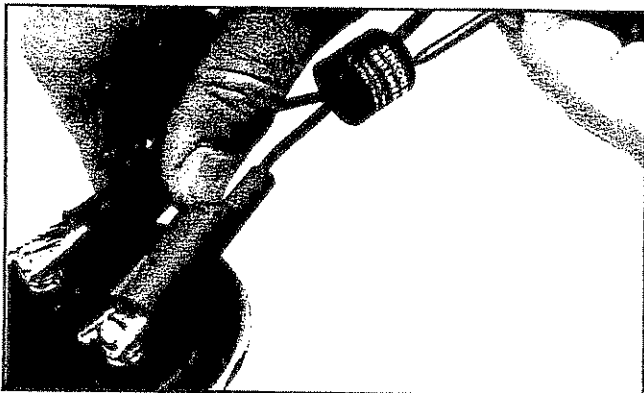

Fig. 10: The 39G144 test lead adapter allows large screw terminal capacitors to be connected to the LC101.

To Use the 39G144:

1. Connect the Red E-Z Hook® on the LC101 test leads to the red terminal of the 39G144 TEST LEAD ADAPTOR. Connect the Black clip to the other terminal.
2. Connect the Red alligator clip of the 39G144 to the positive screw terminal and the Black alligator clip to the negative terminal.
3. Test the capacitor in the usual manner.

Checking Capacitors For Leakage

Capacitors will often read the correct value but exhibit leakage which may affect their operation in the circuit. The Z METER will check capacitors for this leakage at their rated working voltage up to 1000 Volts. There are two leakage current ranges, 0 to 100 uA and 0 to 10K uA and 16 voltages from 1.5 Volts to 1000 Volts DC. The voltage is applied to the test leads only when the LEAKAGE button is depressed. The capacitor is automatically discharged when the LEAKAGE button is released.

WARNING

This instrument is to be operated by a technically trained person only — who understands the shock hazard of up to 1000 Volts applied to the test leads during the capacitor leakage test. DO NOT hold the capacitor in your hand or touch the test leads or capacitor leads when making the leakage test with 35 Volts or more.

NOTE: The red area of the LEAKAGE VOLTAGE switch should be observed. Voltages in this area are 35 Volts and above and could cause a shock hazard. The blinking LED is an extra reminder that the LEAKAGE VOLTAGE switch is set to 35 Volts or greater. Always observe the red area of the switch in case the extra reminder LED is burned out.

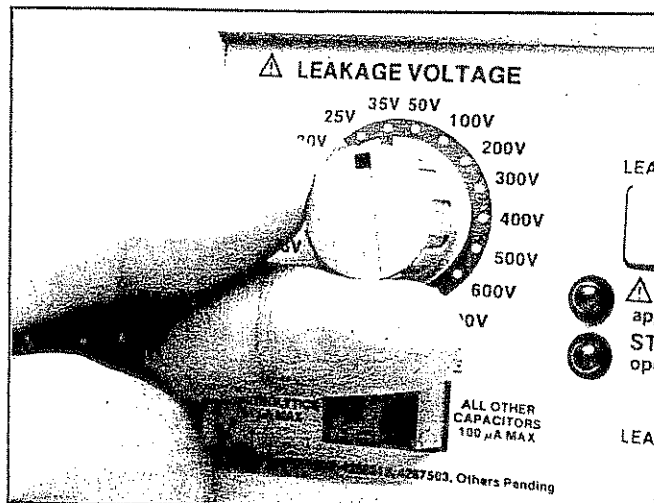

Fig. 11: To test capacitor leakage, set the LEAKAGE VOLTAGE switch to the rated working voltage of the capacitor.

To Check a Capacitor for Leakage

1. Connect the capacitor to be tested to the test leads. If the capacitor is polarized, connect the positive capacitor terminal to the red test lead and the negative terminal to the black test lead.

2. Select the desired current range with the LEAKAGE RANGE switch. Use the ALL OTHER CAPACITORS (100 μ A max) range for most small electrolytics, paper, mica, film, and ceramic capacitors. Use the LARGE ALUM. ELECTROLYTICS (100K μ A max) range for large electrolytics. Consult the leakage chart to determine which range should be used. Start with the highest range (Large Aluminum Electrolytics) if you are not sure which range to use. If the display shows "000", switch to the other range. You can switch ranges of the LEAKAGE RANGE switch while holding the LEAKAGE button in.

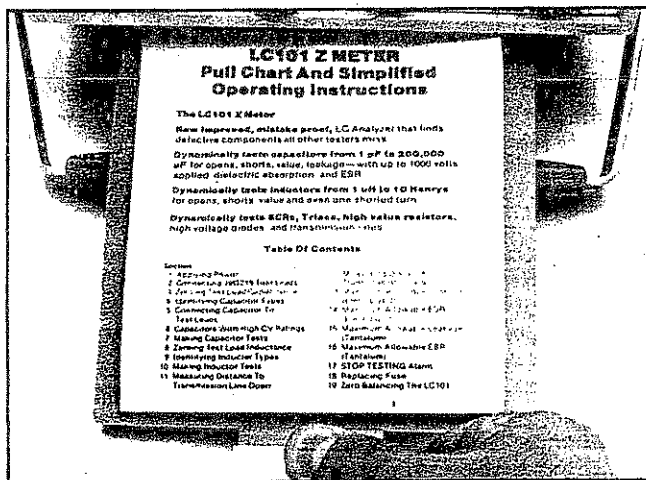

Fig. 12: Consult the leakage charts on the pull chart under the LC101 or the leakage charts in this manual for the maximum allowable leakage of aluminum and tantalum electrolytics.

3. Select the normal DC working voltage of the capacitor with the LEAKAGE VOLTAGE switch. If the capacitor's normal working voltage falls between switch ranges, select the next lower range. For example, if the capacitor's working voltage is 150 Volts, select the 100 Volt position of the LEAKAGE VOLTAGE switch.

4. Depress the LEAKAGE button and read the amount of leakage current in microamps on the display. Capacitors take a certain amount of time to charge before a reading of the leakage current is displayed.

Ceramic, Paper, Mica, And Film Types:

Use the ALL OTHER CAPACITORS position of the LEAKAGE RANGE switch when testing these capacitors for leakage. The leakage reading should take only 2 to 3 seconds for an accurate display. Some very large value capacitors may show a low leakage reading which quickly changes to 00.0. This is normal and merely shows that the capacitor is charging. If a

reading is still present after about five seconds the capacitor has excessive leakage and should be considered defective.

SPECIAL NOTE ON LOW VOLTAGE CERAMICS: Ceramic capacitors of 50 working volts (WVDC) or greater have a very high insulation resistance and should not show any leakage. Ceramic capacitors with working voltages lower than 50 Volts have a much lower insulation resistance and may show leakage. While the actual insulation resistance varies from manufacturer to manufacturer, a general rule of thumb is 10 WVDC capacitors may normally show as much as 16 μ A of leakage and 25 WVDC ceramic capacitors may show up to 2.5 μ A of leakage. Make a comparison test, if possible, between a known good capacitor and the suspect capacitor when in doubt. In most cases, these low voltage capacitors will only be used in circuits where this high leakage will not upset the circuit operation.

Aluminum Electrolytics:

The charging time for aluminum electrolytics varies with capacity and applied voltage. On larger electrolytics, the meter will overrange (show flashing 888) until the charging current drops below 10 mA. The typical amount of overranging time can be determined from chart 2. After the LC101 stops overranging the display usually begins at a high leakage reading and drops with each display update. This shows the charging action of the capacitor through the impedance of the APPLIED VOLTAGE power supply circuits. When a lytic is fully charged, the reading will change in small steps, either up or down. These small changes simply indicate that the capacitor under test is attempting to filter small changes in the AC power line voltage. It is not necessary, in most cases, to wait until the capacitor is fully charged to determine if it is good. Just depress the LEAKAGE button until the leakage drops below the maximum allowable level as shown in the tables below or on the pull out chart under the Z METER.

If the LARGE ALUM. ELECTROLYTIC (10K μ A max) range is used first and the reading drops to 000,

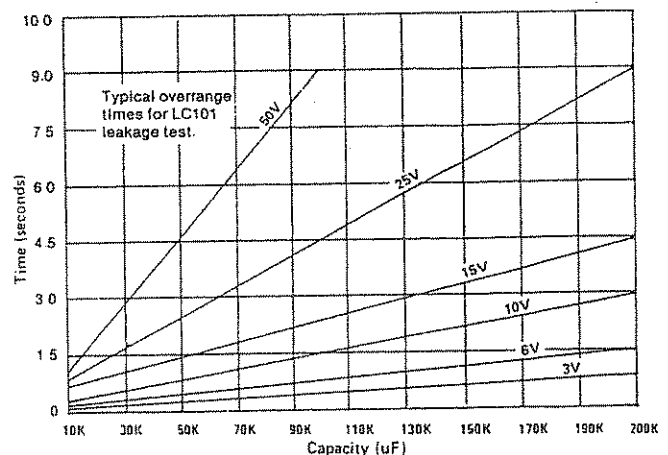

Table 2 — Meter Overrange time versus capacitor value and applied voltage.

simply change the LEAKAGE RANGE switch to the ALL OTHER CAPACITORS (100 uA max) range while depressing the LEAKAGE button. Ignore the first two readings after changing ranges as switching ranges changes the series impedance which in turn causes a momentary change in the charging current

Tantalum Electrolytics:

Dipped tantalum electrolytic capacitors have a much lower leakage compared to aluminum electrolytics for the same capacity and working voltage. Tantalum electrolytics will give a leakage reading in a very short period of time, usually in just a matter of 2 to 5 seconds.

Leakage Charts

The leakage charts that follow, and on the pull chart below the LC101, show the maximum allowable leakage for the most common aluminum electrolytic and dipped tantalum capacitors. Good capacitors will show leakage values lower than the values in the leakage charts. You do not need to wait for the measured leakage to drop to zero or to its lowest point. The capacitor is good for any leakage reading lower than the amount shown.

Leakage value for aluminum electrolytics are the worst case conditions as specified by the Electronics Industry Association (EIA) standards RS-395 using the following formula: $L=0.05 \times CV$ (for CV products less than 1000 uF) or $L=6 \times \text{square root of } CV$ (for CV

Maximum Allowable Leakage (in Microamps)																
Standard Aluminum Electrolytic Capacitors																
Capacity in uF	1.5V	3.0V	6.0V	10V	15V	20V	25V	35V	50V	100V	200V	300V	400V	500V	600V	1000V
1.0	5	5	5	5	5	5	5	5	5	5	10	15	20	25	30	50
1.5	5	5	5	5	5	5	5	5	5	5	8	15	23	30	38	45
2.2	5	5	5	5	5	5	5	5	6	11	22	33	44	199	218	281
3.3	5	5	5	5	5	5	5	6	8	17	33	50	218	244	267	345
4.7	5	5	5	5	5	5	6	8	12	23	47	225	260	291	319	411
6.8	5	5	5	5	5	7	9	12	17	34	221	271	313	350	383	495
10	5	5	5	5	8	10	13	18	25	50	268	329	379	424	465	600
15	5	5	5	8	11	15	19	26	38	232	329	402	465	520	569	735
22	5	5	7	11	17	22	28	39	199	281	398	487	563	629	689	890
33	5	5	10	17	25	33	41	204	244	345	487	597	689	771	844	1090
47	5	7	14	24	35	47	206	243	291	411	582	712	823	920	1008	1301
68	5	10	20	34	192	221	247	293	350	495	700	857	990	1108	1212	1565
100	8	15	30	50	232	268	300	355	424	600	849	1039	1200	1342	1470	1897
150	11	23	45	232	285	329	367	435	520	735	1039	1273	1470	1643	1800	2324
220	17	33	218	281	345	398	445	526	629	890	1259	1541	1780	1990	2180	2814
330	25	50	267	345	422	487	545	645	771	1090	1541	1888	2180	2437	2670	3447
470	35	225	319	411	504	582	650	770	920	1301	1840	2253	2602	2909	3186	4113
680	192	271	383	495	606	700	782	926	1106	1565	2213	2710	3129	3499	3832	4948
1000	232	329	465	600	735	849	949	1122	1342	1897	2683	3286	3795	4243	4648	6000
1500	285	402	569	735	900	1039	1162	1375	1643	2324	3286	4025	4648	5196	5692	7348
2200	345	487	689	890	1090	1259	1407	1665	1990	2814	3980	4874	5628	6293	6893	8899
3300	422	597	844	1090	1335	1541	1723	2039	2437	3447	4874	5970	6893	7707	8443	
4700	504	712	1008	1301	1593	1840	2057	2434	2909	4113	5817	7125	8227	9198		
6800	606	857	1212	1565	1916	2213	2474	2927	3499	4948	6997	8570	9895			
10000	735	1039	1470	1897	2324	2683	3000	3550	4243	6000	8485					
15000	900	1273	1800	2324	2846	3286	3674	4347	5196	7348						
22000	1090	1541	2180	2814	3447	3980	4450	5265	6293	8899						
33000	1335	1888	2670	3447	4221	4874	5450	6448	7707							
47000	1593	2253	3186	4113	5038	5817	6504	7695	9198							
56000	1739	2459	3478	4490	5499	6350	7099	8400								
68000	1916	2710	3832	4948	6060	6997	7823	9256								
100000	2324	3286	4648	6000	7348	8485	9487									
150000	2846	4025	5692	7348	9000											
220000	3447	4874	6893	8899												

NOTE: No industry standards are available for component values in the shaded areas. These values have been extrapolated from existing standards and manufacturers data. All values not shaded are based on existing EIA industry standards.

Table 3 — Maximum allowable leakage for aluminum electrolytics per EIA standards.

Maximum Allowable Leakage (in Microamps)

Dipped Solid Tantalum Capacitors

Capacity	1.5V	3.0V	6.0V	10V	15V	20V	25V	35V	50V	100V	200V	300V	400V	500V	600V	1000V
1.0	1.0	1.0	1.0	1.0	1.0	1.0	1.0	1.0	1.0	3.5	4.9	6.1	7.0	7.8	8.6	11
1.5	1.0	1.0	1.0	1.0	1.0	1.0	1.4	1.0	2.0	4.3	6.1	7.4	8.6	9.6	11	14
2.2	1.0	1.0	1.0	1.0	1.0	1.0	1.8	1.2	2.0	5.2	7.3	9.0	10	12	13	16
3.3	1.0	1.0	1.0	1.0	1.0	1.5	2.2	2.0	3.0	6.4	9.0	11	13	15	17	24
4.7	1.0	1.0	1.0	1.0	1.5	2.0	2.6	2.5	3.5	7.6	11	13	16	18	20	29
6.8	1.0	1.0	1.0	1.5	2.0	2.5	3.0	3.0	5.0	8.8	11	16	19	22	25	35
10	1.6	1.6	1.6	2.0	2.5	3.0	4.0	5.0	7.8	11	16	19	23	27	30	43
15	2.2	2.2	2.2	2.5	3.0	4.0	7.0	5.0	9.6	14	19	23	28	33	37	52
22	2.8	2.8	2.8	3.0	5.0	9.5	10	10	12	16	23	28	33	37	40	64
33	3.4	3.4	3.4	5.0	7.5	15	10	11	14	20	28	35	40	45	49	76
47	4.0	4.0	4.0	10	10	15	15	16	17	24	34	42	48	54	59	91
68	5.0	5.0	5.0	15	15	20	15	17	20	29	41	50	58	65	71	111
100	10	10	10	15	20	20	17	21	25	35	49	61	70	78	86	136
150	15	15	15	20	20	19	21	25	30	43	61	74	86	96	105	164
220	20	20	20	20	20	23	26	31	37	52	73	90	104	116	127	201
330	20	20	20	20	25	28	32	38	45	64	90	110	127	142	156	240
470	24	24	24	24	29	34	38	45	54	76	107	131	152	170	186	289
680	29	29	29	29	35	41	46	54	65	91	129	158	183	204	224	350
1000	35	35	35	35	43	49	55	65	78	111	157	192	221	247	271	429
1500	43	43	43	43	53	61	68	80	96	136	192	235	271	303	332	519
2200	52	52	52	52	64	73	82	97	116	164	232	284	328	367	402	636
3300	64	64	64	64	78	90	101	119	142	201	284	348	402	450	492	759
4700	76	76	76	76	93	107	120	142	170	240	339	416	480	537	588	913
6800	91	91	91	91	112	129	144	171	204	289	408	500	577	645	707	1107
10000	111	111	111	111	136	157	175	207	247	350	495	606	700	783	857	1356
15000	136	136	136	136	166	192	214	254	303	429	606	742	857	959	1050	1642
22000	164	164	164	164	201	232	260	307	367	519	734	899	1038	1161	1272	2011
33000	201	201	201	201	246	284	318	376	450	636	899	1101	1272	1422	1557	2399
47000	240	240	240	240	294	339	379	449	537	759	1073	1314	1518	1697	1859	2999
68000	289	289	289	289	353	408	456	540	645	913	1291	1581	1825	2041	2236	3500
100000	350	350	350	350	429	495	553	655	783	1107	1565	1917	2214	2475	2711	4287
150000	429	429	429	429	535	606	678	802	959	1356	1917	2348	2711	3031	3320	5191
200000	495	495	495	495	606	734	783	971	1100	1570	2210	2710	3130	3500	3830	5191

NOTE: No industry standards are available for component values in the shaded areas. These values have been extrapolated from existing standards and manufacturers data. All values not shaded are based on existing EIA industry standards.

Table 4 — Maximum allowable leakage for solid tantalum electrolytics per EIA standards.

products greater than 1000 uF). (The CV product is equal to the capacitance value multiplied by the voltage rating).

Leakage values for dipped tantalum capacitors are based on EIA standard RS228-B. The values listed in the leakage chart are for the most commonly used tantalum capacitors, type 3.3. In a few applications outside consumer service, tantalum capacitors other than type 3.3 may be encountered. Refer to the individual manufacturers specifications for the maximum allowable leakage of these special capacitors. Some values of tantalum capacitors listed in the chart are not covered by existing EIA leakage standards. These values are identified by the shaded areas and were extrapolated from EIA standard RS228-B using the formula: $L = .35 \sqrt{CV}$.

NOTE: In the above formulas L is the maximum leakage current in microamps, C is the capacitor value in uF, and V is the rated voltage of the capacitor.

Non-polarized electrolytic capacitors should be measured for leakage in both directions. Make the leakage test, then reverse the test leads and repeat the test. Some non-polarized electrolytics have one lead connected internally to the case. The allowable leakage for these types is twice that of a regular electrolytic of the same capacity and voltage rating.

Identifying Capacitor Types

The capacitor has increased in use tremendously in the past few years. Many new types and improved versions are now in use. The following information is provided as a guide to aid in identifying the type of capacitor and its value. The color charts cover most of the variations that will be encountered. There may be others not covered here and in those cases, consult the manufacturer of the equipment for information.

Tantalum Electrolytics:

Dipped Tantalum electrolytics are becoming very common in electronic circuits. Its low leakage current and smaller physical size make it a standout for solid state circuits. Tantalum electrolytics can be made to tighter tolerances than aluminum electrolytics. Tantalums are not marked as such and the schematic generally does not indicate the lytic as a tantalum. The dipped tantalum electrolytic is smaller (about one-half or less) than the same capacity and voltage aluminum electrolytic. Dipped tantalum capacitors come in many sizes and shapes, as shown in figure 13. Some use a color code to show the positive lead while others are marked with the value and a + on the positive lead. Other tantalums use the shape of the lead or a rounding of a corner to indicate the positive lead.

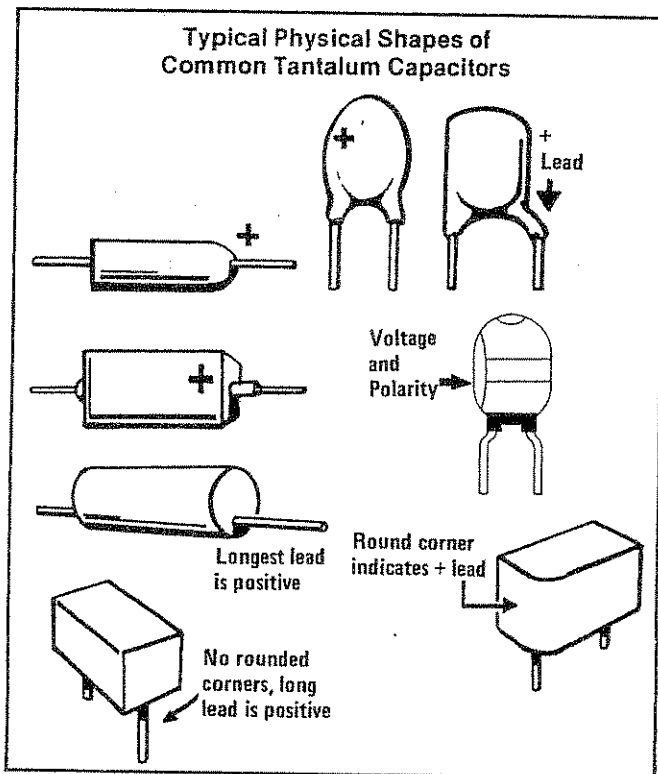

Fig. 13: Solid tantalum electrolytics come in all sizes and shapes. The most common shapes are shown here.

Ceramic Discs:

The ceramic disc is well-known and can be identified by its round shape and generally brown color. Some ceramic discs come in different colors such as blue and

green due to a different coating material on the outside. Most ceramic discs are marked with the value and the tolerance. The most common working voltage (500 Volts) is generally not marked, but anything different is normally found on the capacitor body. There are other markings such as NPO, GMV, N1500, or similar. These are the temperature coefficients or how much the capacitor will change with a change in temperature. When replacing a ceramic disc, be sure to use the same exact type that was used in the original circuit. NPO stands for Negative-Positive-Zero or no change in capacity. GMV is Guaranteed Minimum Value and the actual value could be much higher. The letter N indicates that the capacity will decrease with an increase in temperature, and if you find one with a letter P, that one will increase in capacity with an increase in temperature. Further information will be found in the section on "Capacitor Theory and the Z METER" and in the Glossary at the back of this manual.

Ceramic capacitors may also be found in shapes other than the familiar disc shape. Some common shapes of ceramic capacitors are shown in figure 14. Generally, only replace a ceramic capacitor with one that has characteristics identical to the one removed from the circuit. Using a different type may cause improper circuit operation.

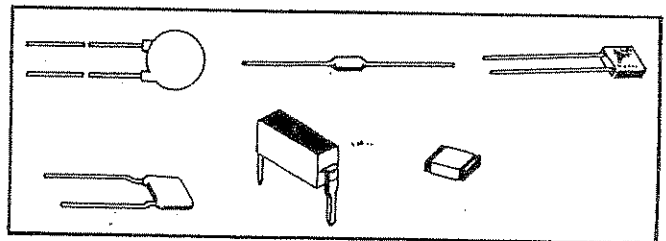

Fig. 14: Ceramic capacitors come in shapes other than the familiar disc. Other shapes of ceramic capacitors are shown here.

Film Types:

These are the hardest to identify as to the type of film being used. The type of film is not generally marked and it could be any one of at least five types. On these capacitors you will have to consult the manufacturer's service information for the correct type. It should be noted that a Mylar capacitor is not a universal replacement for any film type capacitor. Each film has different characteristics and must be replaced with the same type of film used in the circuit. This is especially true in those areas of schematics that are designed as "Safety Critical".

Testing For Dielectric Absorption

Dielectric absorption is the inability of a capacitor to completely discharge to zero. This is sometimes called "battery action" or "capacitor memory" and is due to the dielectric of the capacitor retaining a charge. All capacitors have some dielectric absorption, but electrolytic capacitors have the highest amount and will often affect circuit operation if it becomes excessive. You can check lytics for dielectric

absorption during the normal test for capacitor value and leakage. Simply recheck the value of the capacitor after the leakage test in the following manner using the Sencore patented dielectric absorption test.

1. Connect the capacitor to the test leads and test for the capacitor value in the normal manner. Note capacity reading on the LC101.

2. Test the capacitor for leakage at its rated working voltage. Allow the leakage current shown on the display to drop to the maximum allowable leakage shown on the leakage charts in the manual or on the pull chart under the LC101.

3. Release the LEAKAGE button and allow the display to drop to 000. Immediately depress the VALUE button and note the capacitor reading.

a. If the capacity reading is within 5% of the original value and the reading increases slowly upward toward the original value, or there is no difference in the readings, the capacitor has very little dielectric absorption and is good.

b. If the value reading difference is greater than 5% but less than 15%, the capacitor may require reforming as described in the next section. Some of the dielectric oxide has deteriorated and reforming the lytic may bring it back to a useful life. Recheck for dielectric absorption often while attempting to reform the capacitor.

c. If the difference in values is greater than 15% and the reading after the leakage test changes upward rapidly toward the original value, the capacitor has excessive dielectric absorption. Electrolytic capacitors exhibiting this much dielectric absorption may be reformed in some cases. However, if the capacitor exhibits similar dielectric absorption after reforming has been attempted, it should be replaced as it will give trouble in the circuit.

NOTE: If a mica or film type capacitor shows any dielectric absorption, it can be considered "bad" and should be replaced.

Reforming Lytics On The Z METER

Aluminum electrolytics will often show low value or high leakage if they have been sitting on a shelf for a long period of time. Generally any aluminum electrolytic capacitor sitting on the shelf for over one year will show up in this manner. This is caused by a loss of some of the oxide coating that forms the dielectric of the capacitor. In many cases, the oxide coating may be reformed with the application of a DC voltage for a period of time. The Z METER can reform the dielectric material by using the same DC power supply that is used for leakage testing. Reforming may require more than an hour before the capacitor returns to its normal condition. The 39G201 TEST BUTTON HOLD DOWN ROD is included with the Z METER to hold the LEAKAGE button down for reforming lytics.

A special clip is mounted on the rear of the instrument for storage of the 39G201 when it is not in use.

WARNING

Use the 39G201 with extreme caution! Do not touch the test leads or the capacitor leads while the 39G201 is being used. Make sure that the capacitor being reformed will not touch any metal or come in contact with any metal object while it is being reformed. The voltage from the LEAKAGE VOLTAGE switch is present on the test leads when the LEAKAGE button is depressed.

NOTE: Observe the red area on the LEAKAGE VOLTAGE switch. This indicates a voltage of 35 to 1000 Volts DC and can be dangerous. The special LED will also blink on and off to indicate that the LEAKAGE VOLTAGE switch is set to 35 to 1000 Volts but rely on the red area of the switch in case the LED burns out.

To Use the 39G201 Test Button Hold Down Rod:

1. Connect the lytic to be reformed to the test leads observing polarity.

2. Select the proper voltage with the LEAKAGE VOLTAGE switch. Observe the above warning when using 35 Volts or more.

3. Depress the LEAKAGE button, and while holding the button in, place the 39G201 on the button. Bring the handle to the front of the meter and adjust the 39G201 so it fits securely between the handle and the LEAKAGE button, holding the LEAKAGE button depressed.

4. After the capacitor has been reformed for at least one hour, allow it to discharge and sit for about 30 minutes. Then recheck the value and the leakage to see if the reforming processed has improved the capacitor.

WARNING

NEVER use the Test Button Hold Down Rod to hold down any switch except the Leakage switch. Damage to the LC101 is possible if you latch another switch because the protection circuits are bypassed with a button depressed. The warranty will be voided if the LC101 is damaged by connecting to a charged capacitor or a powered circuit with one of the switches held down.

SPECIAL NOTES: 1. This method of holding the LEAKAGE button in provides greater safety than a "latching" switch. Always observe extreme caution when you see the handle in front of the switches as this will tell you voltage is being applied to the test leads and capacitor. Never attempt to operate any other function pushbuttons when the 39G201 is being used. 2. The 39G201 Test Button Hold Down Rod is a spring loaded. The spring on the threaded shaft

prevents the adjustable portion of the holder from moving after you have adjusted it to the correct length.

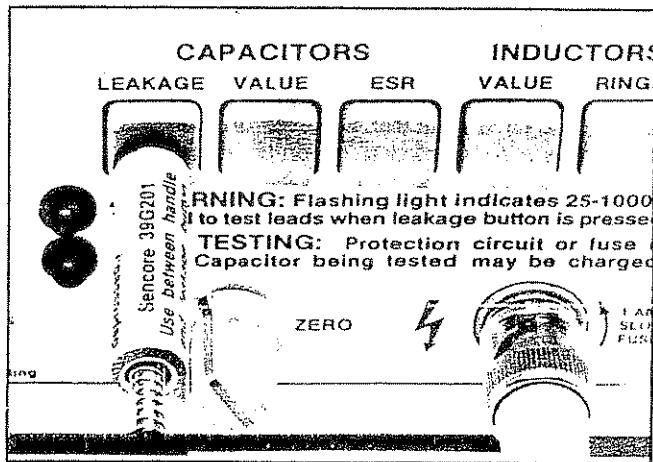

Fig. 15: The Test Button Hold Down Rod keeps the LEAKAGE button depressed when reforming caps and also serves as a safety reminder that voltage is being applied to the test leads.

Reforming Lytics With A Power Supply

A separate DC power supply may be used to reform a capacitor. The power supply must have voltage output equal to the capacitor's working voltage, and should be adjustable from zero to allow the voltage to be increased slowly. The power supply should also have a DC current meter or an external meter must be used to monitor the charging current.

CAUTION

Always use a series limiting resistor when applying voltage from an external power supply. This will prevent the capacitor from charging too fast and causing permanent damage to the capacitor.

WARNING

This instrument is to be operated by a technically trained person only — who understands the shock hazard of up to 1000 Volts applied to the test leads during the capacitor leakage test. DO NOT hold the capacitor in your hand or touch the test leads or capacitor leads when making the leakage test with 35 Volts or more.

To Use the External Power Supply to Reform Lytics:

1. With the power supply turned OFF, connect the positive power supply terminal, through a 1000 Ohm, 5 Watt resistor and the external current meter (if required) to the positive terminal of the lytic to be reformed.
2. Connect the negative terminal of the power supply to the negative terminal of the lytic.

3. Set the output voltage control on the power supply to minimum.

4. Turn the power supply ON and slowly increase the voltage while watching the current meter. Do not allow the charging current to go above 50 mA. If the meter reads higher than 50 mA, stop increasing the voltage until the current drops below this level. Then slowly increase the voltage again while watching the current meter until the DC working voltage of the capacitor is reached. Allow the capacitor to remain at its full rated working voltage for at least 30 minutes.

5. Turn the power supply off and allow the capacitor to discharge. After the capacitor has discharged for at least one hour, recheck the value and leakage on the Z METER to see if further reforming is necessary.

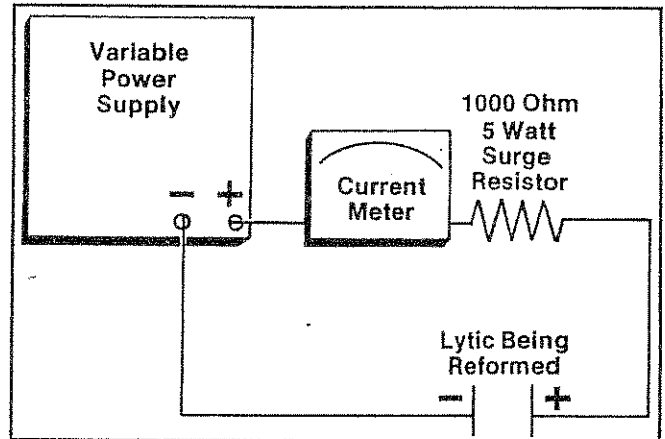

Fig. 16: An electrolytic may be reformed using an external power supply, other than the LC101. Be sure to use a series current limiting resistor and a current meter to monitor the restoring current.

Checking Capacitors For ESR

Electrolytic capacitors may develop abnormally high levels of internal resistance. Equivalent series resistance (ESR) is most often a problem in capacitors which are used in high frequency filtering applications, such as switching power supplies and AGC circuits. In these applications high series resistance interferes with the normal filtering action and causes improper circuit operation. In addition, the power dropped by the resistance may cause the capacitor to overheat.

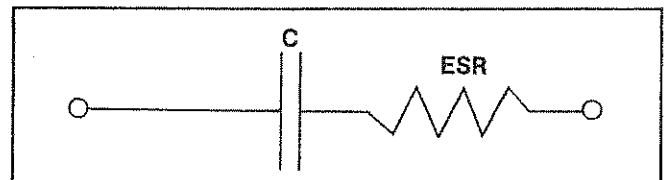

Fig. 17: Losses in the dielectric and foil connections may all be grouped together into a single equivalent series resistance.

Capacitors can be tested for high ESR values using the patent pending LC101 ESR test. To determine if a capacitor is good or bad simply measure the ESR with the LC101 and compare the measured value to the

values listed in the charts in tables 5 and 6 or on the pull chart below the LC101. These values are the maximum allowable ESR limits established by the EIA for common aluminum and dipped tantalum electrolytic capacitors. The figures are the worst case conditions and good capacitors will show ESR values well below the amounts listed in the tables.

The ESR values for aluminum electrolytics in table 5 are based on EIA standard RS 395 and the ESR values for dipped tantalums listed in table 6 are based on EIA standard RS 228-B. Some capacitor values listed in the tables are not covered by existing EIA standards. These values are indicated by shaded areas in the charts and were extrapolated from the existing standards.

To measure ESR:

1. Connect the capacitor to the LC101 test leads. For polarized capacitors connect the positive terminal to the red test lead and the negative terminal to the black test lead.
2. Depress the Capacitor ESR test button and read the amount of resistance in ohms on the digital display.
3. Compare the measured ESR to the value listed in the ESR tables under the capacitance value and voltage rating of the capacitor you are testing.

Maximum Allowable ESR (in Ohms)

Standard Aluminum Electrolytic Capacitors

CAPACITY InuF	1.5V	3.0V	6.0V	10V	15V	20V	25V	35V	50V	100V	200V	300V	400V	500V	600V	1000V
1.0	663	663	663	663	464	464	464	464	332	332	265	265	265	265	265	265
1.5	442	442	442	442	310	310	310	221	221	177	177	177	177	177	177	177
2.2	302	302	302	302	211	211	211	151	151	121	121	121	121	121	121	121
3.3	201	201	201	201	141	141	141	101	101	80	80	80	80	80	80	80
4.7	141	141	141	141	99	99	99	71	71	56	56	56	56	56	56	56
6.8	98	98	98	98	68	68	68	49	49	39	39	39	39	39	39	39
10	66	66	66	66	46	46	46	33	33	27	27	27	27	27	27	27
15	44	44	44	44	31	31	31	22	22	18	18	18	18	18	18	18
22	30	30	30	30	21	21	21	15	15	12	12	12	12	12	12	12
33	20	20	20	20	14	14	14	10	10	8.04	8.04	8.04	8.04	8.04	8.04	8.04
47	14	14	14	14	9.88	9.88	9.88	7.06	7.06	5.65	5.65	5.65	5.65	5.65	5.65	5.65
68	9.76	9.76	9.76	9.76	6.83	6.83	6.83	4.88	4.88	3.90	3.90	3.90	3.90	3.90	3.90	3.90
100	6.63	6.63	6.63	6.63	4.64	4.64	4.64	3.32	3.32	2.65	2.65	2.65	2.65	2.65	2.65	2.65
150	4.42	4.42	4.42	4.42	3.10	3.10	3.10	2.21	2.21	1.77	1.77	1.77	1.77	1.77	1.77	1.77
220	3.02	3.02	3.02	3.02	2.11	2.11	2.11	1.51	1.51	1.21	1.21	1.21	1.21	1.21	1.21	1.21
330	2.01	2.01	2.01	2.01	1.41	1.41	1.41	1.01	1.01	.804	.804	.804	.804	.804	.804	.804
470	1.41	1.41	1.41	1.41	.988	.988	.988	.706	.706	.565	.565	.565	.565	.565	.565	.565
680	.976	.976	.976	.976	.683	.683	.683	.488	.488	.390	.390	.390	.390	.390	.390	.390
1000	.663	.663	.663	.663	.464	.464	.464	.332	.332	.265	.265	.265	.265	.265	.265	.265
1500	.442	.442	.442	.442	.310	.310	.310	.221	.221	.177	.177	.177	.177	.177	.177	.177
2200	.302	.302	.302	.302	.211	.211	.211	.151	.151	.121	.121	.121	.121	.121	.121	.121
3300	.201	.201	.201	.201	.141	.141	.141	.101	.101	.080	.080	.080	.080	.080	.080	.080
4700	.141	.141	.141	.141	.099	.099	.099	.071	.071	.056	.056	.056	.056	.056	.056	.056
6800	.098	.098	.098	.098	.068	.068	.068	.049	.049	.039	.039	.039	.039	.039	.039	.039
10000	.066	.066	.066	.066	.046	.046	.046	.033	.033	.027	.027	.027	.027	.027	.027	.027
15000	.044	.044	.044	.044	.031	.031	.031	.022	.022	.018	.018	.018	.018	.018	.018	.018
22000	.030	.030	.030	.030	.021	.021	.021	.015	.015	.012	.012	.012	.012	.012	.012	.012
33000	.020	.020	.020	.020	.014	.014	.014	.010	.010							
47000	.014	.014	.014	.014	.010	.010	.010									
56000	.012	.012	.012	.012												
68000	.010	.010	.010	.010												

NOTE: No industry standards are available for component values in the shaded area. These values have been extrapolated from existing standards and manufacturers data. All values not shaded are based on existing EIA industry standards.

Table 5 — Maximum allowable ESR for aluminum electrolytics per EIA standards.

Maximum Allowable ESR (in Ohms)

Dipped Solid Tantalum Capacitors

CAPACITY in μF	1.5V	3.0V	6.0V	10V	15V	20V	25V	35V	50V	100V	200V	300V	400V	500V	600V	1000V
1.0	133	133	133	79.6	79.6	79.6	79.6	66.3	66.3	66.3	66.3	66.3	66.3	66.3	66.3	66.3
1.5	88.4	88.4	88.4	53.1	53.1	53.1	53.1	44.2	44.2	44.2	44.2	44.2	44.2	44.2	44.2	44.2
2.2	60.3	60.3	60.3	36.2	36.2	36.2	36.2	30.1	30.1	30.1	30.1	30.1	30.1	30.1	30.1	30.1
3.3	40.2	40.2	40.2	24.1	24.1	24.1	24.1	20.1	20.1	20.1	20.1	20.1	20.1	20.1	20.1	20.1
4.7	28.2	28.2	28.2	16.9	16.9	16.9	16.9	14.1	14.1	14.1	14.1	14.1	14.1	14.1	14.1	14.1
6.8	19.5	19.5	19.5	11.7	11.7	11.7	11.7	11.7	11.7	11.7	11.7	11.7	11.7	11.7	11.7	11.7
10	13.3	13.3	13.3	7.96	7.96	7.96	7.96	7.96	7.96	7.96	7.96	7.96	7.96	7.96	7.96	7.96
15	8.84	8.84	8.84	5.31	5.31	5.31	5.31	5.31	5.31	5.31	5.31	5.31	5.31	5.31	5.31	5.31
22	6.03	6.03	6.03	3.62	3.62	3.62	3.62	3.62	3.62	3.62	3.62	3.62	3.62	3.62	3.62	3.62
33	4.02	4.02	4.02	2.41	2.41	2.41	2.41	2.41	2.41	2.41	2.41	2.41	2.41	2.41	2.41	2.41
47	2.82	2.82	2.82	1.69	1.69	1.69	1.69	1.69	1.69	1.69	1.69	1.69	1.69	1.69	1.69	1.69
68	1.95	1.95	1.95	1.17	1.17	1.17	1.17	1.17	1.17	1.17	1.17	1.17	1.17	1.17	1.17	1.17
100	1.33	1.33	1.33	0.80	0.80	0.80	0.80	0.80	0.80	0.80	0.80	0.80	0.80	0.80	0.80	0.80
150	0.88	0.88	0.88	0.88	0.88	0.88	0.88	0.53	0.53	0.53	0.53	0.53	0.53	0.53	0.53	0.53
220	0.60	0.60	0.60	0.60	0.60	0.60	0.60	0.36	0.36	0.36	0.36	0.36	0.36	0.36	0.36	0.36
330	0.40	0.40	0.40	0.40	0.40	0.40	0.40	0.24	0.24	0.24	0.24	0.24	0.24	0.24	0.24	0.24
470	0.28	0.28	0.28	0.28	0.28	0.28	0.28	0.17	0.17	0.17	0.17	0.17	0.17	0.17	0.17	0.17
680	0.20	0.20	0.20	0.20	0.20	0.20	0.20	0.12	0.12	0.12	0.12	0.12	0.12	0.12	0.12	0.12
1000	0.13	0.13	0.13	0.13	0.13	0.13	0.13	0.08	0.08	0.08	0.08	0.08	0.08	0.08	0.08	0.08
1500	0.09	0.09	0.09	0.09	0.09	0.09	0.09	0.05	0.05	0.05	0.05	0.05	0.05	0.05	0.05	0.05
2200	0.06	0.06	0.06	0.06	0.06	0.06	0.06	0.04	0.04	0.04	0.04	0.04	0.04	0.04	0.04	0.04
3300	0.04	0.04	0.04	0.04	0.04	0.04	0.04	0.02	0.02	0.02	0.02	0.02	0.02	0.02	0.02	0.02
4700	0.03	0.03	0.03	0.03	0.03	0.03	0.03	0.02	0.02	0.02	0.02	0.02	0.02	0.02	0.02	0.02
6800	0.02	0.02	0.02	0.02	0.02	0.02	0.02	0.01	0.01	0.01	0.01	0.01	0.01	0.01	0.01	0.01

NOTE: No industry standards are available for component values in the shaded areas. These values have been extrapolated from existing standards and manufacturers data. All values not shaded are based on existing EIA industry standards.

Table 6 — Maximum allowable ESR for dipped solid tantalum electrolytics per EIA standards.

To Eliminate Test Lead Resistance

When measuring very low amounts of ESR you should zero out the test lead resistance with the LEAD ZERO control. Once the LEAD ZERO control has been set for ESR zero it should not need to be readjusted for capacitance or inductance lead zeroing. If the LEAD ZERO must be reset refer to the section "Zeroing Adjustments" on page 36 in the Maintenance section.

To adjust ESR lead zero:

1. Short the red and black test leads together.
2. Depress the Capacitor ESR button.
3. Adjust the LEAD ZERO control until the meter reads 0.00 with the minus sign appearing occasionally.

Capacitor Testing Application Tips

No Value Reading On Small Value Capacitors

A shorted capacitor will normally give a 000 readout. However, some capacitors, with values generally below 1000 pF, may give a 000 readout on capacitor VALUE even though they are not shorted. These capacitors have a low value leakage current, which may be read using the capacitor LEAKAGE test. This small value of leakage current will upset the capacity measuring circuit of the Z METER and cause the 000 readout.

Leakage In Ceramic, Paper, Film, And Mica Capacitors

Ceramic, paper, film, and mica type capacitors should not show any leakage at all. The maximum allowable leakage is below the sensitivity of the measuring circuit. If any of these type capacitors exhibit leakage, they are defective.

Dielectric Stress

The capacity of many ceramic capacitors changes when they are DC-biased. This value change is caused by "dielectric stress". The applied DC potential causes physical stress within the ceramic dielectric material, causing a decrease in value. It takes several seconds for the capacitor to return to its non-stressed mode after removing the bias.

Dielectric stress causes the capacitor to read a lower capacity value on the LC101 immediately after performing a leakage test compared to the capacity value read just before the leakage test. After the leakage test, the capacitance value slowly builds back up as the dielectric stress dissipates. This effect looks like dielectric absorption in other types of capacitors. Small value ceramic capacitors show a larger percentage than larger ones, often as much as 50% for values less than 10 pF. Capacitors 40 pF and larger should normally show less than a 15% value change.

Checking For Leakage Between Sections Of A Multi-Section Lytic

Multiple section lytics are common in many power supplies. Leakage sometimes develops between two or more sections of a multiple section type. This leakage may be due to an internal short circuit, or a build-up of dirt between the terminals on the outside of the capacitor. This type of leakage is particularly difficult to troubleshoot because the signal from one section of the capacitor is coupled to the other section which results in multiple symptoms in the operation of the device in which the capacitor is used.

An ohmmeter will often fail to show this leakage because it only occurs at or near the capacitor's operating voltage.

The Z METER quickly locates this type of leakage while performing the standard leakage test. Simply short out the sections that are not being tested for leakage while the leakage of the first section is tested. An increase in leakage indicates internal leakage between sections and a bad capacitor.

WARNING

The following procedure should only be performed by a qualified person who understands the potential hazard of up to 1000 Volts being applied to the test leads while making the leakage test. Do not touch the Red test lead clip or the capacitor terminal it is connected to during the test or while the LEAKAGE button is depressed.

To test for leakage between sections of multi-section capacitor:

1. Connect one section of the capacitor to the test leads observing polarity.
2. Set the LEAKAGE VOLTAGE switch to the proper voltage for the section being tested. Be sure to use the

correct voltage as many multi-section capacitors have different voltages for each section.

3. Depress the LEAKAGE button and observe the leakage current reading on the display.
4. Connect one end of a short jumper to the common terminal of the capacitor and while depressing the LEAKAGE button, connect the other end of the jumper to one of the remaining capacitor terminals not connected to the test leads. A good electrolytic will show no change in the leakage reading. A capacitor with leakage between sections will show an increase in leakage when the short is applied to the untested terminal.

NOTE: Be sure to test all the terminals of the multi-section lytic against each other for leakage between sections.

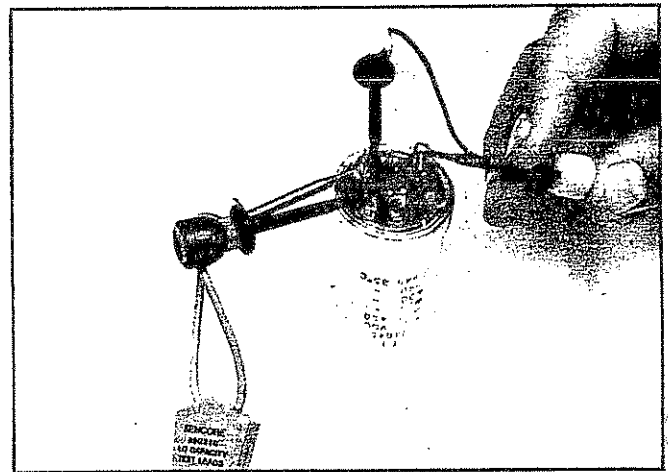

Fig. 18: Test the leakage of one section of a multi-section electrolytic and then short one of the remaining sections to ground. An increase in leakage current indicates leakage between that section and ground.

Large Fluctuations In Electrolytic Leakage Readings

Leakage readings on lytics will normally start at some high value and then decrease as the capacitor charges up. When the capacitor is fully charged, there will be a small variation in the leakage reading indicating that the capacitor is trying to filter out the small variations in the line voltage. When the variations become rather large and change in large jumps, suspect an intermittent lytic. Lytics that exhibit this symptom will give trouble in the circuit and should be rejected.

Leakage Measurements Of Non-Polarized Electrolytics

Leakage measurements on non-polarized lytics must be made in both directions. Simply make the leakage test, note the leakage current, and then reverse the leads and make the leakage test again. If both ends of the non-polarized lytic are insulated from the case, the maximum allowable leakage is the same as listed in the

leakage chart. If one end is connected to the case, the allowable leakage is doubled.

Electrolytics Sitting In Stock

Electrolytic capacitors that have been sitting on the shelf for extended periods of time may show high leakage when checked. These lytics should be reformed according to the information in this manual under "Reforming Lytics with the Z METER or "Reforming Lytics with a Power Supply." Generally, an electrolytic that has been sitting and is checked for value and then leakage may indicate a larger capacity value when the value is rechecked. For example, the lytic may measure 1000 uF when tested before performing the leakage test, the value may now be as high as 1100 uF. This indicates that the lytic was partially reformed when the leakage was tested. This type of lytic can often be reformed to its original capacity with the Z METER or power supply or when placed in the circuit and allowed to run for a period of time.

Intermittent Capacitors

Occasionally a capacitor becomes intermittent. A poor weld of the lead to the foil or other mechanical malfunction can cause the capacitor to operate in a random fashion. The leads of a suspected capacitor should be moved around or pulled on when making the Value test. A change in capacity indicates a intermittent problem.

An intermittent caused by a bad weld can sometimes show up as flashing 888 on the meter. This is due to the capacity changing at the time the VALUE button is depressed and the meter cannot lock in on a range.

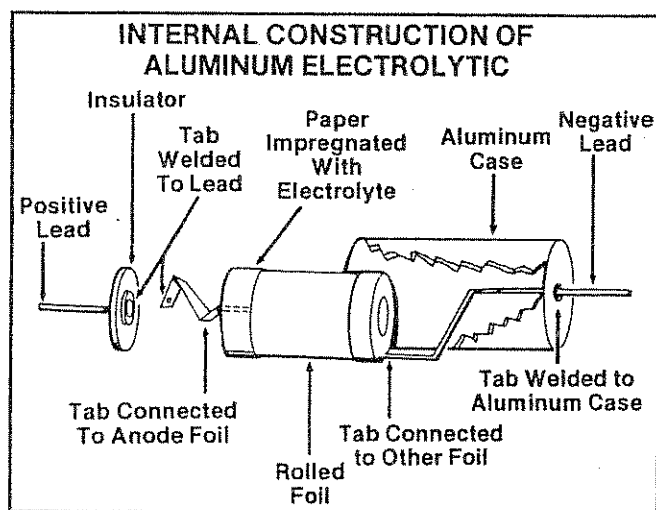

Fig. 19: An electrolytic can become intermittent due to a poor or corroded weld.

Time Required To Obtain A Value Reading On A Capacitor

Capacitors of 1000 uF and below will read almost instantaneously. More time is required for capacitors above this value. The actual time depends upon the RC time constant of the capacitor. For example, a 50,000

uF will read in only 3 seconds and a 100,000 uF takes only 7 seconds. The meter will read 000 until the counting circuit has reached the proper level and then the capacity reading will appear on the display.

On very large capacitors, generally over 100,000uF, the first reading may differ from later readings by as much as 10 percent. This is normal and caused by the dielectric absorption found in most types of capacitors. This slight change in readings should cause no problem because the tolerances of these capacitors are generally -20%, +80% which means that the first reading will be close enough to locate capacitors that have changed value outside the tolerance limits. If you require a very precise reading, simply leave the Capacitor VALUE button depressed until the Z METER has gone through at least 2 complete reading cycles.

Checking Ceramic Capacitors For Temperature Sensitivity

Ceramic capacitors (often called disc capacitors because of their physical appearance) come in a wide variety of capacity values and temperature tolerances. You can quickly determine the temperature characteristics of the capacitor using the LC101 and a heat source. Simply connect the capacitor to the Z METER and check its capacity. Then apply heat from a soldering iron or heat gun while continuing to measure the capacitor's value. If the capacitor is marked COG or NPO the capacity should not change or change only slightly. If the capacitor is marked with an N, such as N1500, the capacity will decrease as the heat is applied. Capacitors marked with the letter P (not in common usage) will increase capacity with the application of heat.

Checking Film Type Capacitors For Temperature Sensitivity

Film type capacitors normally maintain a fairly constant capacity value over temperature. If they become temperature sensitive they can cause problems in the circuit. By connecting the suspect capacitor to the Z METER and testing the capacity while applying heat from a soldering iron or heat gun, or spraying the capacitor with a "freeze spray", changes in capacity value can be seen. Most film type capacitors should change very little in capacity. If a drastic change is seen, the capacitor has become temperature sensitive and should be replaced. A word of caution here - do not touch the soldering iron to the capacitor. The heat can damage the sensitive plastic film used as a dielectric and make the capacitor useless.

Testing Capacity Of Silicon Diodes And Transistors

The Z METER can measure the capacity of silicon diodes and transistors as well as the reverse leakage paths around the transistor or diode. The connections to measure capacity or leakage and are shown in figure 20. If the readout shows 000 when testing for capacity or flashing 888 when testing leakage, the leads are reversed. No precautions are necessary when testing

capacity, but the following guidelines should be observed when testing leakage.

1. Do not apply more than 3 Volts as set by the LEAKAGE VOLTAGE switch when testing Ibeo.
2. Use the setting of the LEAKAGE VOLTAGE switch that matches the maximum applied voltage specification of the transistor when testing I_{cbo} or I_{ceo}. DO NOT exceed the rating of the transistor as the transistor will go into a zener mode and give an incorrect leakage reading. If left in this manner, damage to the transistor could result.

NOTE: The capacity of germanium transistors and diodes cannot be measured with the LC101. The high leakage of these devices will upset the capacity measuring circuit of the Z METER, causing the readout to show flashing 888 when the VALUE button is depressed. The leakage of germanium devices can be measured with the LC101 leakage test using the same procedures as for silicon devices. Do not exceed the voltage rating of the device as germanium devices can be easily damaged.

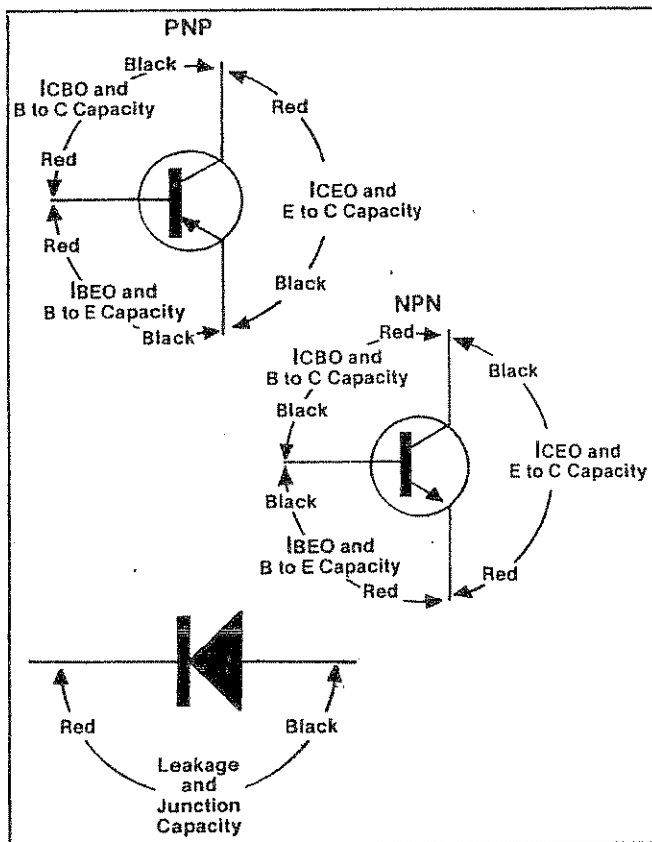

Fig. 20: Connections for measuring capacity of silicon functions. Leakage paths are for both silicon and germanium type junctions.

Testing High Voltage Diodes

High voltage diodes, such as found in TV high voltage and focus voltage sections, cannot be tested on a conventional ohmmeter because they require voltages as high as 200 Volts before they begin to conduct. An

ohmmeter, which typically supplies only 2 Volts, will simply show an open circuit no matter how the leads are connected.

The Leakage test of the LC101 provides sufficient Voltage to allow high voltage diodes to be tested for both forward conduction and reverse leakage. The diode should be tested for forward conduction first to confirm that it is not open. Then, it should be tested for reverse leakage.

WARNING

The following procedures should be performed only by a technically qualified person who understands the potential shock hazard of up to 1000 Volts applied to the test leads when the LEAKAGE button is depressed.

To test a high Voltage diode:

1. Connect the red lead of the LC101 to the anode (- end) of the diode and the black lead to the cathode (+ end).
2. Begin with the LEAKAGE VOLTAGE switch in the 35 Volt position and depress the LEAKAGE button.
3. While holding the LEAKAGE button, increase the LEAKAGE VOLTAGE switch one step at a time until the digital display shows a leakage reading. Do not increase the voltage past the point where the digital readout begins to read. Increased voltage may cause too much current to flow which may ruin the diode.

If you get all the way to 1000 Volts and there is still no reading, the diode is open.

4. Release the LEAKAGE button and reverse the connection of the red and black test leads.
5. Increase the setting of the LEAKAGE VOLTAGE switch to the 1000 volt position.
6. Again depress the LEAKAGE button and observe the digital readout. The digital readout should stay at "000". Any leakage current indicates that the diode is leaky and should be considered defective.

Testing Silicon Controlled Rectifiers (SCRs) And Triacs (With Optional SCR250 SCR/Triac Test Accessory)

SCRs and TRIACs can be tested dynamically on the Z METER using the leakage function of the capacitor test along with the optional SCR250 SCR and TRIAC Test Accessory. SCR and TRIACs can be tested for turn on (latched) conditions and at the full rated working voltage of the device up to 1000 Volts.

All tests on SCR and TRIACs must be performed with the device out-of-circuit. Complete instructions for using the SCR250 are included with the SCR250 Test Accessory.

Determining The Length Of RF Coaxial Cable

The actual length of a piece of coaxial cable, or the location of a break can be determined very accurately with the Z METER. Each type of coax has a nominal amount of capacity per foot of length. Thus, to find the length or distance to the break in the cable, simply measure the capacity of the unterminated cable and divide by the capacity per foot. The Z METER will locate the break regardless if the break is in the shield or the center conductor. The break point and cable length can be found by the simple steps below. If at all possible, measure from both ends of the cable to pinpoint the break much closer.

1. Measure the capacity of the cable (must be open and unterminated) with the Z METER. Connect the red test clip to the center conductor and the black test clip to the shielded braid.

2. Divide the Z METER capacitance reading by the cable capacity per foot. This gives the distance to the break or the length of the cable from the measuring point in feet.

RF COAXIAL CABLE
50 - 55 Ohm

RG/U Cable Type	Nominal Impedance	Nominal Cap in pF/FT	Nominal Inductance
5B/U	50	29.5	
8U	52	29.5	
8U Foam	50	26	
8A/U	52	29.5	
10A/U	52	29.5	
18A/U	52	29.5	
58/U	53.5	28.5	
58/U Foam	50	26	
58A/U	50	30.8	
58C/U	50	29.5	
58C/U Foam	50	26	
74A/U	52	29.5	
174/U	50	30-30.8	
177/U	50	30	
212/U	50	29.5	
213/U	50	30.5	
214/U	50	30.5	
215/U	50	30.5	
219/U	50	30	
225/U	50	30	
224/U	50	30	

Table 7— Capacitance per foot of typical RG coaxial cable.

This test can also be used to determine the length of or pinpoint breaks in multiconductor cable having 3 or more wires. Follow the same procedure as above. Tie all but one of the conductors together to form the "shield". Measure the capacitance between the shield group of wires and the single conductor. You can determine the capacitance per foot for the cable using the procedure in the section "How To Determine Inductance or Capacitance Per Foot Of Coaxial Cable" on page 28.

NOTES: 1. The accuracy of the measurement depends upon the cable capacity tolerance since the value listed is a nominal figure and varied slightly with manufacturer. The normal tolerance for coaxial cable is within the 2% of the LC101. 2. Locations of excessive crimping or clamping change the capacity and will affect the overall reading. 3. The Z METER will not read the capacity if the cable is terminated. The following section indicates how to locate a short. 4. The accuracy of measurements on non-coaxial cable is not as good due to variations in conductor spacing and stray noise pickup.

RF COAXIAL CABLE
70 - 75 Ohm

RG/U Cable Type	Nominal Impedance	Nominal Cap in pF	Nominal Inductance uH/FT
6A/U	75	20	
6A/U Foam	75	20	
11U	75	20.5	
11U Foam	75	17.3	
11A/U	75	20.5	
12A/U	75	20.5	
13A/U	74	20.5	
34B/U	75	20	
35B/U	75	20.5	
59/U	73	21	
59/U Foam	75	17.3	
59/U Double Shield	75	17.3	
59/U	75	20.5	
164/U	75	20.5	
216/U	75	20.5	
82 Channel	73	17.5	

RF COAXIAL CABLE
90 - 125 Ohm

RG/U Cable Type	Nominal Impedance	Nominal Cap in pF	Nominal Inductance uH/FT
62/U	93	13.5	
62A/U	93	13.5	
63B/U	125	10	
71B/U	93	13.5	
79B/U	125	10	

How To Find A Short In A Coaxial Cable

A break in a coaxial cable may be located with the Capacity test as indicated in the previous section. A shorted cable, however, will not read on the Capacity test. The inductance test should be used to locate a short.

The amount of inductance per foot is generally not published by the cable manufacturer. This value may be determined by using the Z METER to measure a known length of the cable (as explained in the next section) before performing the Inductance test. Space has been left in the charts above for the inductance per foot to be added as you encounter different cables.

To find the approximate distance to a short:

1. Measure the inductance of the shorted cable. The red test clip should be connected to the center conductor and the black test clip to the shield braid.
2. Divide the reading obtained by the inductance per foot that you have measured to find the distance in feet from the measuring point to the short. To more accurately locate a short, measure the cable from both ends.

How To Determine Inductance Or Capacitance Per Foot Of Coaxial Cable

A known length of cable can be measured with the Z METER to find the value of inductance or capacitance per foot. A length of at least 20 to 25 feet is recommended to obtain an accurate inductance reading. A length of 10 feet may be used to obtain a capacitance value.

1. Connect the known length of cable to the Z METER, the center conductor to the red test clip, and the shield braid to the black test clip. Short the center conductor to the shield at the opposite end when testing inductance only.
2. Measure the inductance or capacitance. Divide the reading obtained by the length of the cable. Record this figure in the chart for future reference.

NOTE: The inductance may vary slightly with the same type of cable due to the variations in manufacture. The measuring tolerance to the point of a short should be within 2% in most cases.

Inductors

The Z METER measures the actual inductance of coils using a patented circuit. To measure inductance simply connect the test leads to the coil and depress the VALUE button and read the inductance in uH or mH on the display.

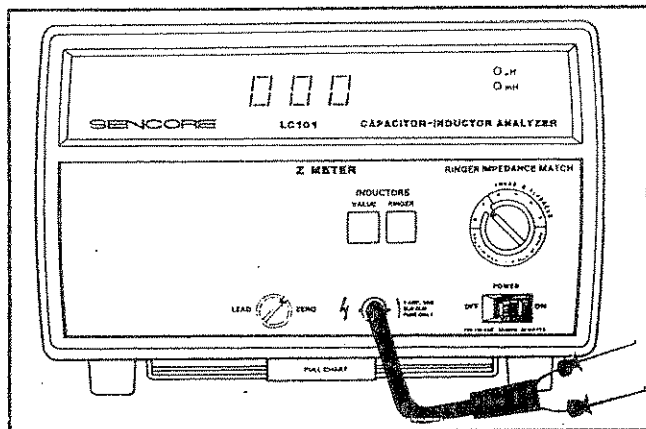

Fig. 21: Controls used for inductor testing.

WARNING

Do not connect the test leads to a circuit having power applied. Be sure the power is "OFF" by disconnecting the AC line cord to the equipment under test.

Checking Inductors For Inductance Value

1. Connect the test leads to the coil or transformer to be tested.
2. Depress the Inductors VALUE button.
3. Read the value of inductance of the coil or transformer on the digital display. The LED will light in front of uH if the value is in microhenrys or in front of mH if the value is in millihenrys.

NOTE: A reading of flashing 888 with a steady zero indicates an open circuit. Recheck your lead connections to make sure you are connected to the proper terminals.

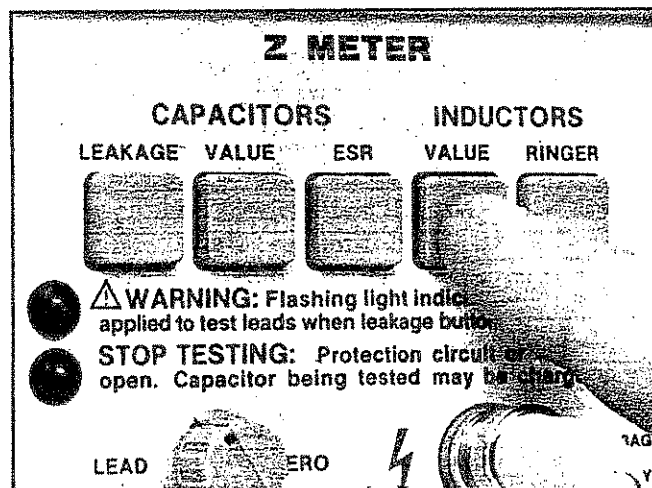

Fig. 22: To measure inductance, connect the inductor to the test leads, depress the VALUE button and read the amount of inductance on the digital display.

Balancing Out Lead Inductance

The above procedure provides accurate readings on inductors over 1000 μH . Small value inductors between 2 μH and 1000 μH may be off slightly due to the inductance of the test leads. This inductance may be balanced out for high accuracy readings with the LEAD ZERO control.

1. Place the test leads on the work area in such a way that they will not be moved when connecting a coil. Be sure the leads are not on a metal surface, near AC power or an AC operated device. Short the test lead clips together.
2. With the test leads shorted, depress the Inductance VALUE button and adjust the LEAD ZERO control until the display reads 00.0 with the negative sign appearing occasionally.

NOTE: Adjust the LEAD ZERO control slowly as the LC101 requires about 2 seconds between readings when the test leads are shorted.

3. Carefully connect the coil to the test leads being careful not to disturb the position of the leads if possible. Depress the INDUCTORS VALUE button and read the inductance value on the display.

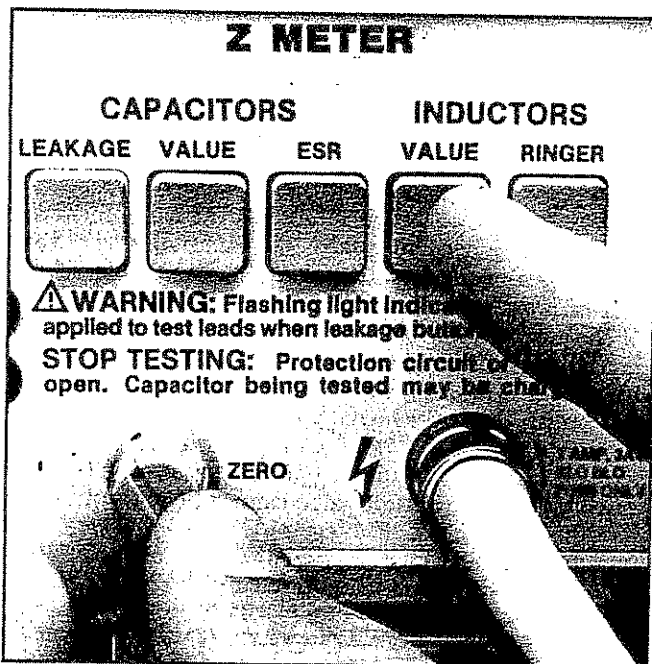

Fig. 23: Zero out the test lead inductance when measuring small value inductors.

Once the LEAD ZERO control has been set for inductance zero it should not need to be readjusted for capacitance or ESR lead zero. If the control must be reset refer to the section "Zeroing Adjustments" on page 36.

Checking Coils Below 2 Microhenrys

The Z METER may show a reading of 00.0 for coils under 2 μH in value. This is due to the "zero window"

that is necessary in the autoranging circuit. Values of coils below 2 μH can be read by offsetting the meter with the LEAD ZERO control.

To Read Value of Coils Below 2 μH :

1. Place the test leads on the work area in such a way that they will not be moved when the coil is connected.
2. Short the test leads together. Depress the INDUCTORS VALUE button and offset the LEAD ZERO control until the display shows a reading of 2.0 μH .
NOTE: If the LEAD ZERO control is turned in the wrong direction, a negative sign will appear in front of the reading. Adjust the LEAD ZERO control for a positive reading.
3. Unshort the test leads and carefully connect the coil to the test leads without disturbing their position.
4. Depress the INDUCTORS VALUE button and obtain a reading on the digital display. Subtract the 2 μH offset from the reading on the display for the actual inductance value of the coil. For example, if the display shows a reading of 2.8 μH , the actual value is 2.8 minus 2.0, or 0.8 μH .

Open Winding In A Coil

Open windings in coils are easily spotted with the Z METER, while checking the inductance value. If the display shows flashing 888 with a stationary 0 during the inductance test the coil is open. If the coil is a small wire type, be sure to check the fine wires that go to the solder lugs on the coil form. The fine wire can be broken easily from tension or extreme heat and cold variations.

On large transformers that have several taps or windings in series, simply check across the entire winding for an open. The actual open can be isolated by moving one lead down the series of taps until the Z METER gives an inductance reading. The tap above this point has the open winding.

NOTE: On multitap transformers such as flyback transformers, check the terminals the test leads are connected to. If the Z METER shows an open, you may be connected to the wrong terminals.

Checking Inductance In-Circuit

WARNING

Do not connect the test leads to a circuit having power applied. Be sure the power is "OFF" by disconnecting the AC line cord to the set under test.

The Z METER will check the value of inductors in-circuit for their actual inductance value. Simply connect the test leads to the coil, depress the INDUCTORS VALUE button and read the

inductance value on the display. In-circuit inductance measurements will be affected by the impedance of the circuit which the inductor is in. Small values of parallel resistance lower the circuit impedance causing the inductance value to read lower than its actual value. The amount of resistance that can parallel the inductor and decrease the inductance value by 10% or less are as follows:

2 to 90 μ H	3.9 to 45 Ohms
90 μ H to 900 μ H	45 to 390 Ohms
900 μ H to 9 mH	390 to 1200 Ohms
9 mH to 90 mH	1.2K to 3.9K Ohms
90 mH to 900 mH	3.9K to 7.2K Ohms
900 mH to 9000 mH	7.2K to 27K Ohms

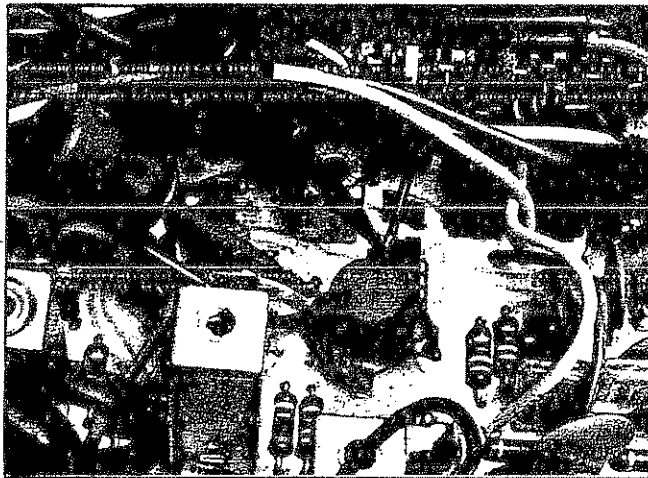

Fig. 24: Inductance values can be checked in-circuit with the LC101 inductance test.

Values of resistance larger than those listed will cause measuring errors less than 10% while resistance values smaller than these will change the measured inductance by more than 10%.

Measuring the inductance values of a coil in circuit is a quick and easy way to determine if it is open. If the coil is open and is not shunted by a resistor, the LC101 will read flashing 888. If, however, a coil is open and shunted by a resistor (something that might be missed with an ohmmeter) the Z METER will not read the correct value, but a much higher value. For example, coils which normally run around .2 or .5 μ H will read about 2.8 mH if a 1K ohm resistor is shunting the open coil.

Testing Inductors On Printed Circuit Boards

On most PC boards, the leads to any components are very short which may make connections difficult. The E-Z Hook[®] clips used with the Z METER will connect to many of the coils that you wish to test. When there is no lead to connect to, you can use the (optional) Sencore 39G85 Touch Test Probe accessory to make contact with the leads of the coils. Connect the 39G85 to the Z METER test leads as follows:

1. Connect the Red clip of the test leads to the R point on the top of the 39G85. Connect the Black clip to the Y point on the top of the 39G85.

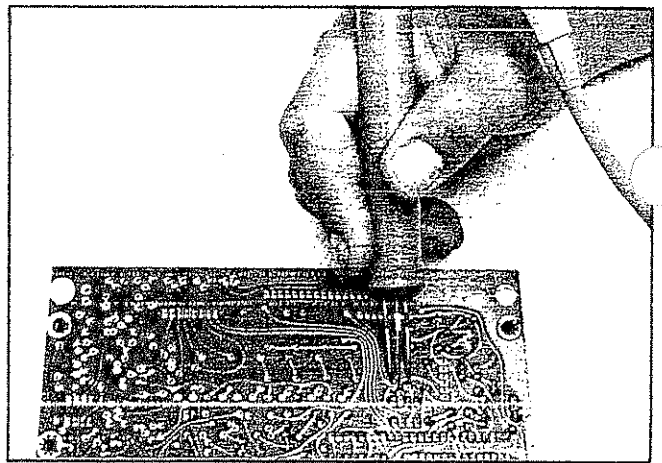

Fig. 25: The optional Touch Test Probe can be used with the Z METER to check the inductance and ringing of coils that are mounted flat on the PC board.

NOTE: These are the two longest probe points and will make it easier to use when checking coils.

2. Make contact to the point on the PC board for one side of the coil to be tested with the Red probe point and apply slight pressure to hold it in place. Then make contact to the other coil point with the Yellow probe point and apply pressure to hold the 39G85 in place.

3. Depress the INDUCTORS VALUE button and read the inductance on the digital display.

Mutual Inductance

If two or more coils are wound on the same form and connected either internally or externally the total inductance measured from end to end with the Z METER will not be equal to the measured inductance of the individual windings. The measured value may be higher or lower than the measured value of the individual windings due to the mutual inductance of the coils. The measured value of the total will be affected by the spacing between the windings, the type of windings used, and the core material used to wind the coils on. The actual value cannot be determined by simply looking at the coils. The Z METER will measure the actual inductance of the combination of coils just as the circuit would see it.

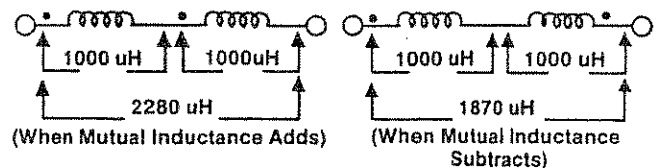
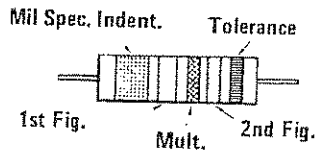

Fig. 26: The Z METER will show the actual inductance of two coils with mutual inductance. Mutual inductance can either add or subtract from the individual reading of the windings.

Inductor Coding

Inductors are marked using several different color codes. The two most commonly used marking systems

TUBULAR ENCAPSULATED RF CHOKES



Color	Figure	Multiplier	Tolerance
Black	0	1	
Brown	1	10	
Red	2	100	
Orange	3	1,000	
Yellow	4		
Green	5		
Blue	6		
Violet	7		
Gray	8		
White	9		
None			20%
Silver			10%
Gold			5%

Multiplier is the factor by which the two color figures are multiplied to obtain the inductance value of the choke coil in μH . Values will be in μH .

Table 8— Typical inductor color codes.

are shown in table 8. These two codes are by no means all the codes that may be encountered. When a strange code is found, consult the manufacturer's service literature for the values.

Checking Inductors For Good Or Bad With The Ringing Test

The patented Ringing test allows you to determine if coils (without iron cores) are good or bad with an accurate but easy to perform test of the quality or "Q" factor of the coil. A special impedance matching circuit establishes a reference for all coils larger than 10 μH . A good coil should show a reading of 10 or more on the digital display. A bad coil will show less than 10 ringing cycles.

The LC101 Ringing test measures the "Q" factor by applying a reference pulse to the coil and then digitally counting the number of ringing cycles produced until the signal is damped to a preset level. A shorted turn in a coil will lower its Q and cause the ringing to dampen faster than in a good coil. An open coil will show no ringing.

While the patented Sencore Ringing test is based on the Q of the coil, the readings on the Z METER often

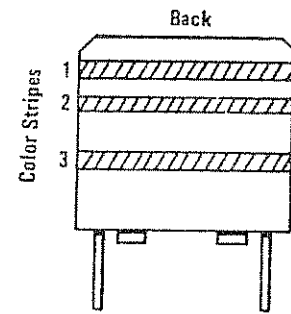

"POSTAGE STAMP" FIXED INDUCTORS

Color	1st Digit 1st Strip	2nd Digit 2nd Strip	Multiplier 3rd Strip
Black or (Blank)	0	0	1
Brown	1	1	10
Red	2	2	100
Orange	3	3	1,000
Yellow	4	4	10,000
Green	5	5	100,000
Blue	6	6	
Violet	7	7	
Gray	8	8	
White	9	9	
Gold			X.1
Silver			X.01

RINGER IMPEDANCE MATCH

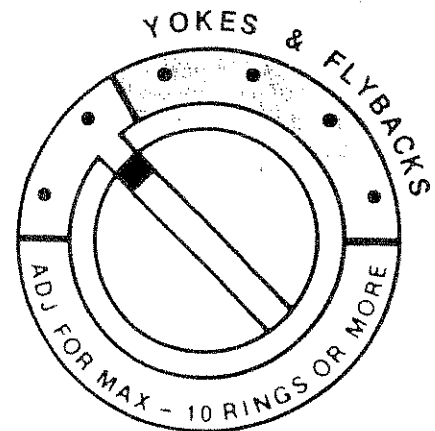

Fig. 27: The four red positions of the IMPEDANCE MATCH switch are for TV yokes and flybacks. Use all six positions for other coil and transformer types.

will not agree with those obtained with a bridge or a Q meter. The reason is simply that the LC101 "Q" test has been simplified to make the number 10 a reference point.

The Ringing Test IMPEDANCE MATCH switch is

divided into two sections. The four positions marked in red are the only positions that should be used for testing television yokes and flybacks. The sensitivity of the Ringing test circuits in these positions is matched to the impedance and frequency specifications of these special coils.

All six positions should be used for testing other types of coils. The two positions marked in blue have additional sensitivity to allow small value coils to be tested accurately. The four red positions will match properly to large value coils.

Special Notes On Inductor Testing

1. The Ringing test should not be used on coils and transformers having laminated iron cores such as power transformers, audio output transformers, and filter chokes. The iron core in these types of transformers and coils absorbs the ringing energy of the coils and results in low readings that are unreliable.

2. Good coils below 10 μH in value may not ring 10 cycles. The low inductance of these coils generally allows only about 2 to 4 cycles. A comparison test should be made on a known good coil to see if the Q factor results are correct.

3. Some coils above 10 μH may not show 10 or more rings due to the nature of the construction or core material used in the coil. These may show 8 or 9 rings and still be good. The quality of these coils may be confirmed by adding a "Shorted Turn" and rechecking the ringing of the coil. If the coil is bad, the number of rings will not change or will change very little, indicating the coil already has a shorted turn. If the number of rings drops off drastically, then the coil is good. A good "shorted turn" can be made from a piece of solder wrapped around the coil tightly and twisted together at the ends. Do not use small diameter wire or stranded wire for the shorted turn as this wire does not give the same effect and could give misleading results.

To Test the Quality of a Coil with the Ringing Test:

1. Connect the test leads to the inductor to be tested.

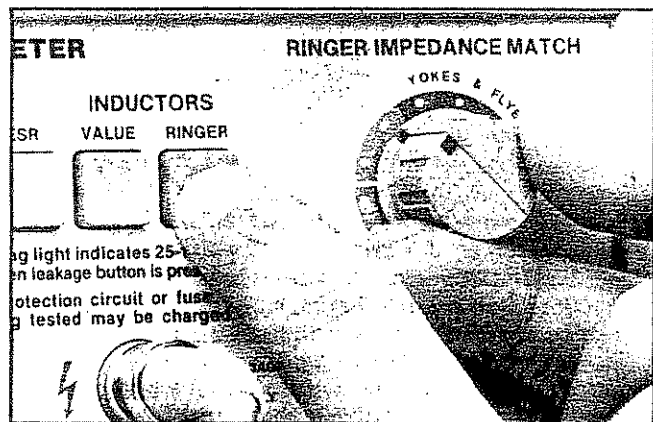

Fig. 28: Check inductors for quality by connecting the test leads, depressing the RINGER button and rotating the IMPEDANCE MATCH switch while watching the display for the number of ringing cycles.

2. Depress the RINGER button. Hold the button down and rotate the IMPEDANCE MATCH switch through all 6 positions for regular inductors or through the last 4 positions for TV yokes and flybacks.

3. If a reading of 10 or more appears on the display in one or more positions of the IMPEDANCE MATCH switch, the inductor is good. If a reading of less than 10 is displayed on all positions of the switch, the inductor is defective. Refer to the Inductor Testing Applications and the section on testing yokes and flybacks for further information.

NOTE: The Z METER may show a continuously changing reading when using the two most sensitive positions of the IMPEDANCE MATCH switch in the presence of high AC power radiation. This can occur if 1.) The coil is open and near a source of high level AC power radiation, 2.) The leads are not connected properly, connected to the wrong terminal, or not making proper contact and picking up AC radiation, 3.) Touching the Red test clip and injecting AC into the Z METER, and 4.) Depressing the Ringing Test button with the leads not connected to anything and near a source of high level AC power radiation. If the continuously changing reading occurs, move the coil being tested to a location away from the source of AC radiation and check the connections to the coil. If you suspect that the coil may be open or the leads not connected properly, merely recheck the inductance value. If the readout shows a flashing 888 with a stationary 0, the coil is open or the leads are not connected properly.

Inductor Testing Applications Tips

The patented Ringing test on the Sencore Z METER has been designed to test coils and transformers for an indication of good or bad. The ringing test can be made in-circuit as well as out of circuit for fast troubleshooting. The following application tips cover special situations you may encounter when testing in-circuit. Review these notes carefully before making any in-circuit test.

Peaking Coils

Coils wound on resistors (peaking coils) may not give a good indication on the Ringing test due to the damping action of the resistor. The lower the value of the resistor, the lower the Ringing test will read. For example, a 1000 μH coil wound on a 10K Ohm resistor will just make 10 rings. The action of the resistor is to dampen out the oscillations or ringing in the circuit and it will do the same on the Ringing test.

Coils In Metal Shields

Coils and transformers that are shielded with a metal shield may not show good when tested with the Ringing test. The metal shield may absorb the ringing energy depending on how close the shield is to the coil. Consider a shielded coil good if it shows 10 or more rings. If the coil shows less than 10 rings in all positions of the IMPEDANCE MATCH SWITCH,

you should either remove the shield and repeat the test or make a comparison test on a know good shielded coil. Be sure the coil is identical to the one in the circuit being tested for accurate results.

Ferrite Core Transformers And Coils

Coils and transformers that use ferrite cores will normally show good ringing if the coil is good. The value of the coil or transformer must be above 10 uH to show a ringing test of 10 or more, just like regular coils.

Testing TV Flyback Transformers With The Ringing Test

The patented Sencore Ringing test allows the testing of yokes and flybacks in- or out-of-circuit. Simply connect the yoke or flyback to the test leads, depress the RINGER pushbutton and rotate the IMPEDANCE MATCH switch through the four yoke and flyback positions (marked in red). A display of 10 or more on any one of the four positions indicates a good yoke or flyback. If the reading is less than 10 in all four positions of the IMPEDANCE MATCH switch, the Ringing test will help locate the cause of the low reading, a shorted turn or a circuit loading the yoke or flyback down.

WARNING

Do not connect the Z METER test leads to the flyback in the set until ALL power to the set has been removed. For your safety, disconnect the AC line cord to the receiver from the AC outlet.

1. Connect the red clip to:
 - a. Plate cap of a tube set
 - b. The Collector or input to the tripler of a solid-state set.
2. Connect the black clip to:
 - a. The cathode of the damper tube or anode of the boosted boost rectifier or similar locations that is DC connected to the plate cap through the windings of the flyback for a tube set.
 - b. The B+ input to the horizontal output transistor or to ground. If the set uses an isolated ground, connect to the B+ input point only.

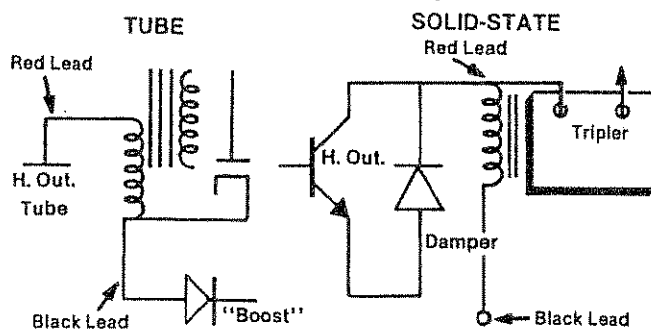

Fig. 29: The Z METER provides a quick in-circuit ringing test on tube or solid state chassis.

3. If the set has a high voltage rectifier tube, remove it as the filaments may act as a short and cause the Z METER to give a false reading of less than 10.

4. Depress the RINGER pushbutton and hold it down while rotating the IMPEDANCE MATCH switch through the four yoke and flyback positions marked in red. If the meter reads 10 or more in one or more positions of the switch, the flyback is good. If the display shows less than 10 in all four positions of the switch, a short or load on the flyback is indicated.

NOTE: The first four steps will identify a good flyback. If a reading of less than 10 is indicated, the flyback may still be good but a circuit could be loading it. Use the remaining steps to locate the defect.

5. If the test results in the previous steps result in a readout of less than 10 in all four positions, unplug or unsolder the yoke leads from the horizontal windings and repeat the test.

6. If the readout is still less than 10 on a solid state set, disconnect one end of the damper diode and repeat the Ringing test.

7. If the readout is still less than 10, unplug the convergence coils and repeat the Ringing test.

8. If the readout is still less than 10, start disconnecting the other coils from the flyback (such as the AGC winding) one at a time. Perform the Ringing test each time a load is disconnected until you either find: 1.) the flyback begins to read good, or 2.) all the leads have been removed from the flyback and it still tests bad. If all the leads have been removed and the display still shows less than 10 in all four positions, the flyback is defective. If, on the other hand, the flyback begins to read good after a load has been removed, the flyback itself is good. The last load to be disconnected should be tested as there may be a short which is loading the ringing circuit. The flyback may be tested out of circuit using the same procedure.

NOTE: The flyback will test "bad" if: 1.) the coil under test is open, 2.) the coil under test has one or more shorted turns, or 3.) any other coil in either the primary or the secondary of the transformer has one or more shorted turns. A shorted turn in any coil will lower the Q of all the other coils through mutual inductance.

A coil in the secondary may occasionally open rather than short. This type of failure will only affect the coil that is open and will not affect the other coils. If the operation of the receiver indicates the possibility of an open winding, leave the Z METER connected to the primary winding and apply a short circuit to each of the other windings in the transformer.

An externally applied short will lower the Q of all the other windings, just like an internal short. Simply note the number of ringing cycles displayed with no external short applied. Then use a small jumper to short out the secondary you wish to test. Repeat the Ringing test with the external short applied. You do not need to rotate the IMPEDANCE MATCH switch

for these additional tests. Simply leave it in the position that gave the highest number of rings when the coil was tested without the external short.

If the secondary coil you are testing is open, you will not see any change in the reading when you depress the RINGER pushbutton with the external short is applied. If, on the other hand, the coil is good, you see fewer ringing cycles displayed. Repeat this test on all the secondary coils.

NOTE: If the transformer has several coils connected in series, simply connect across the ends of the series connected coils. An open in any coil will result in no change in the number of ringing cycles displayed.

Special Notes

Some of the newer yokes and flybacks have been designed with very low inductance for use in certain solid-state receivers. These yokes and flybacks may not ring 10 or more times but may show only 8 or 9 rings even when good. The question of good or bad can be answered quickly by adding a "shorted turn" and rechecking the number of rings. If the number of rings does not change or changes only slightly, then the yoke or transformer already has a shorted turn. If the number of rings drops off drastically, then the yoke or flyback is good. This method can be used on any suspected yoke, flyback, or inductor.

A simple "shorted turn" is a piece of solder or heavy gauge wire. Simply form it into a loop and press it close to the windings of the yoke or wrap it around the core or windings of the flyback. Do not use a fine wire or stranded wire as they do not give the same affect and could give misleading results.

Many of the newer flybacks have the High Voltage rectifier diodes built right into the flyback itself. These are called Integrated High Voltage Transformers (IHVTs) and have the diodes included as part of the transformer winding. Because of the reverse breakdown of the diodes, the high voltage winding cannot be checked directly with the Ringing test. The flyback must be checked from the primary windings to determine if it is good or bad.

If there is a lack of high voltage and the flyback shows good ringing one of the diodes is open. If the high voltage is several thousand volts low and the flyback shows good ringing one of the diodes is shorted. In both cases, the flyback must be replaced as the diodes are not replaceable.

Testing Yokes With The Ringing Test

The LC101 Ringing test provides quick good/bad yoke test. The four red positions of the IMPEDANCE MATCHING switch are used for checking yokes. Yokes should be tested while they are still mounted on the CRT. Occasionally a short caused by the pressure of the yoke mounting. Removing the yoke from the CRT relieves the pressure and the short may disappear.

WARNING

Do not connect the Z METER to the yoke or flyback in the set until ALL power to the set has been disconnected. For your safety, remove the AC line cord of the receiver from the AC outlet.

To Test Horizontal Yoke Windings:

1. Disconnect the yoke leads from the circuit. On sets with a yoke plug, simply pull the plug. If the leads are soldered to the flyback or PC board, carefully unsolder them noting where they were connected.

2. Connect the test leads from the Z METER to the horizontal windings of the yoke. Depress the RINGER pushbutton and hold it down while rotating the IMPEDANCE MATCH switch through the four positions for yoke and flybacks (marked in red). A display of 10 or more on any one of the four positions indicates a good yoke winding. A display of less than 10 on all four positions of the switch indicates a defective yoke.

NOTE: The horizontal windings of the yoke can check good and still have a bad yoke if the vertical windings are bad. Be sure to check both the vertical and the horizontal windings of the yoke with the Ringing test.

To Test Vertical Yoke Windings:

1. Disconnect the yoke from the circuit. On sets with a yoke plug, simply pull the plug. If the leads are soldered to the vertical output transformer or the PC board, unsolder them noting where they were connected so that they may be reconnected or the new yoke connected to the proper points.

2. Check the yoke for damping resistors. Some yokes use a damping resistor across the vertical windings. These should be disconnected at one end as they will swamp out the ringing test and possibly give erroneous results.

3. Connect the test leads from the Z METER to the vertical windings of the yoke. Depress the RINGING TEST button and read the number or ringing cycles on the display. A reading of 10 or more rings in any of the four positions of the IMPEDANCE MATCH switch for yokes and flybacks (marked in red) indicates that the yoke is good. A display of less than 10 in all four positions indicates a defective yoke.

NOTE: On series connected vertical yoke windings, the windings should be tested individually. If there is an imbalance of more than 3 rings or the inductance is more than 10% different between the two windings, the yoke will give trouble in the receiver. A good yoke will give almost identical readings on both windings.

Notes

MAINTENANCE

Introduction

The LC101 is designed to provide reliable service with very little maintenance. A fully equipped Factory Service Department is ready to back the LC101 should any problems develop. A schematic, parts list, and circuit board layouts are included, along with this manual, on separate sheets.

Recalibration And Service

Recalibration of the LC101 is recommended on a yearly basis, or whenever the performance of the unit is noticeably affected. Precise standards are required to insure accurate and National Bureau of Standards (NBS) traceable calibration. For this reason it is recommended that the LC101 be returned to the Sencore Factory Service Department for recalibration. The address of the Service Department is listed below. No return authorization is required to return the LC101 for recalibration or service. In most cases, the unit will be on its way back to you within 3 days after it is received by the Service Department.

Service Department Address: Sencore Factory Service, 3200 Sencore Drive, Sioux Falls, SD 57107.

The Service Department may be called at (605) 339-0100.

Circuit Description And Calibration Procedures

A complete circuit description, and a detailed calibration procedure listing the necessary standards and equipment, are available for the LC101 Z METER. These items may be purchased separately through the Sencore Factory Service Parts Department at the address and phone number listed below.

Replacement Leads

The 39G219 Test Leads on the LC101 are made from a special low capacity cable. Replacing the test leads with a cable other than the low capacity test lead will result in measurement errors. Replacement 39G219 Test Leads are available from: Sencore Parts address: Sencore Service Parts Department, 3200 Sencore Drive, Sioux Falls, SD 57107.

The Service Parts Department may be called at (605) 339-0100.

220 VAC Operation

The LC101 may be modified, at an additional cost, to operate at a line voltage of 220 VAC, 50-60 Hz. This modification can be performed by the Sencore Service Department. Simply return the LC101 to the Service Department address listed above.

Zeroing Adjustments

Several controls on the LC101 are used to balance the measuring circuits for zero agreement. These controls are located on the rear of the LC101 and should be adjusted if it becomes necessary to readjust the front panel LEAD ZERO control between capacitance, inductance, and ESR lead zero. It is normal to have to readjust the front panel LEAD ZERO control from time to time. However, if the Zeroing controls are properly adjusted, capacitance lead zero, inductance lead zero and ESR lead zero should all agree at the same setting of the LEAD ZERO control. The location of the Zeroing controls is shown in figure 30.

To adjust the Zeroing Controls:

1. With no test buttons depressed, adjust the DVM ZERO control, located on the rear panel, for a digital display reading of "000".
2. Short the test leads together and depress the INDUCTORS VALUE test button.
3. Adjust the front panel LEAD ZERO control for a reading of "00.0".
4. Depress the ESR test button with the test leads still shorted.
5. Adjust the rear panel ESR ZERO control for a digital display reading of "0.00".
6. Open the test leads. Place the test clips so they are next to each other but not touching each other.
7. Depress the CAPACITOR VALUE test button. Adjust the rear panel CAP ZERO control for a "00.0" digital display reading.

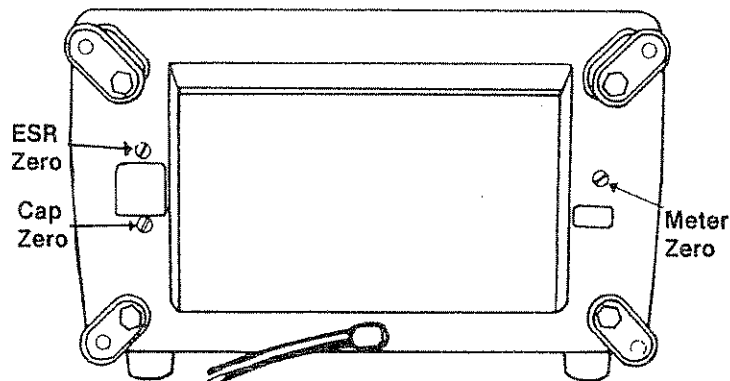

Fig. 30: LC101 Zeroing Adjustments

Notes

APPENDIX

Capacitor Theory And The Z METER

The capacitor is one of the most common components used in electronics, but less is known about it than the other component in electronics. The following is a brief explanation of the capacitor, how it works, and how the Z METER measures the important parameters of the capacitor.

The basic capacitor is a pair of metal plates separated by an insulating material called the dielectric. The size of the plates, the type of dielectric, and the thickness of the dielectric determines the capacity. To increase capacity, you can increase the size of the plates, increase the number of plates, use a different dielectric or a thinner dielectric. The closer the plates, or the thinner the dielectric, the larger the capacity for a given size plate. Because flat plates are rather impractical, capacitors are generally made by putting an insulating material between two foil strips and rolling the combination into a tight package or roll.

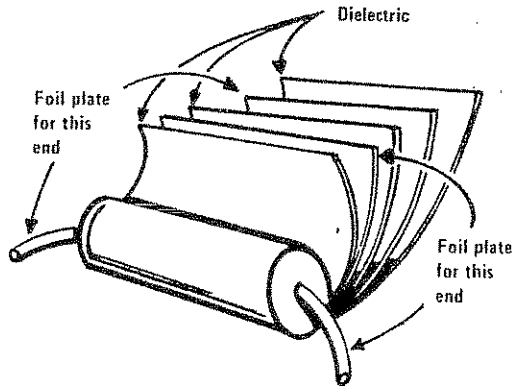

Fig. 31— Many capacitors are made of layers of foil separated by a dielectric and rolled into a tight package.

The old explanation of how a capacitor works had the electrons piling up on one plate forcing the electrons off of the other to charge a capacitor. This made it difficult to explain other actions of the capacitor. Faraday's theory more closely approaches the way a capacitor really works. He stated that the charge is in the dielectric material and not on the plates of the capacitor. Inside the capacitor's dielectric material, there are tiny electric dipoles. When a voltage is applied to the plates of the capacitor, the dipoles are stressed and forced to line up in rows creating stored energy in the dielectric. The dielectric has undergone a physical change similar to that of soft iron when exposed to current through an inductor when it becomes a magnet. If we were able to remove the dielectric of a charged capacitor and then measure the voltage on the plates of the capacitor, we would find no voltage. Reinserting the dielectric and then measuring the plates, we would find the voltage that the capacitor had been charged to before we had removed the dielectric. The charge of the capacitor is actually

stored in the dielectric material. When the capacitor is discharged, the electric dipoles become re-oriented in a random fashion, discharging their stored energy.

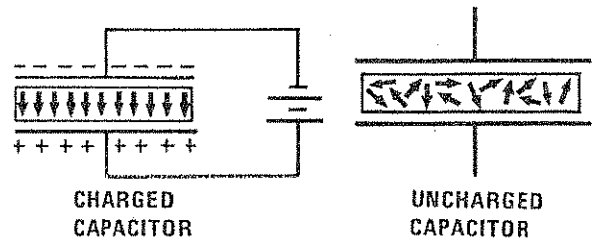

Fig. 32: Applying a potential to a capacitor causes the dipoles in the dielectric to align with the applied potential. When the capacitor discharges the dipoles return to an unaligned, random order.

When a capacitor is connected to a voltage source, it does not become fully charged instantaneously, but takes a definite amount of time. The time required for the capacitor to charge is determined by the size or capacity of the capacitor, and the resistor in series with the capacitor or its own internal series resistance. This is called the RC time constant. Capacity in Farads multiplied by resistance in Ohms equals the RC time constant in seconds. The curve of the charge of the capacitor is the RC charge curve.

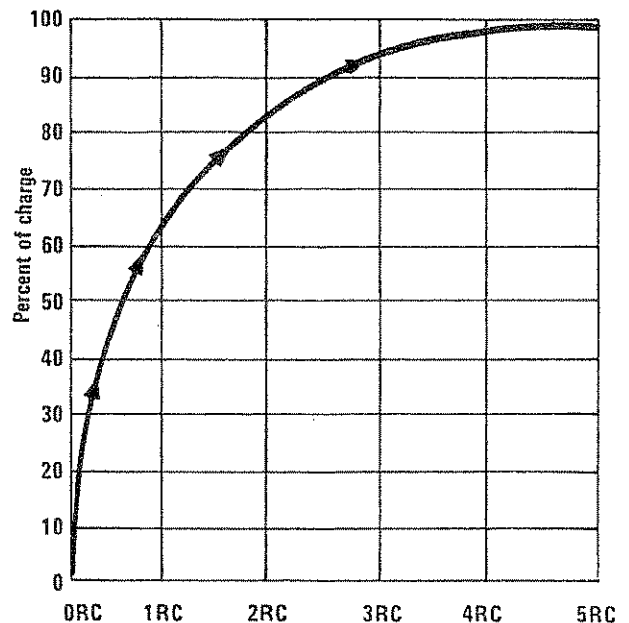

Fig. 33— Capacitors follow an RC charge time as they charge to the voltage applied to them.

The Z METER makes use of this charge curve to measure the capacity of a capacitor. By applying a pulsating DC voltage to the capacitor under test and

measuring the time on its RC charge curve, the capacity of the capacitor can be determined very accurately.

Paper and mica were the standard dielectric materials used in capacitors for years. Ceramic became popular due to its stability and controlled characteristics and lower cost over mica. Today, there are many dielectrics with different ratings and uses in capacitors. Plastic films of Polyester, Polycarbonate, Polystyrene, Polypropylene, and Polysulfone are used in many of the newer large value, small size capacitors. Each film has its own special characteristics and is chosen to be used in the circuit for this special feature. Some of the plastic films are also metalized by vacuum plating the film with a metal. These are generally called self-healing type capacitors and should not be replaced with any other type.

Ceramic dielectric is the most versatile of all. Many variations of capacity can be created by altering the ceramic material. Capacitors that increase, stay the same value, or decrease value with temperature changes can be made. If a ceramic disc is marked with a letter P such as P100, then the value of the capacitor will increase 100 parts per million per degree centigrade increase in temperature. If the capacitor is marked NPO or COG, then the value of capacity will remain constant with an increase in the temperature.

Ceramic disc capacitors marked with an N such as N1500 will decrease in capacity as the temperature increases. The negative temperature coefficient is important in many circuits such as the tuned circuits of the radio and television IF. The temperature coefficient of an inductor is positive and the inductance will increase as the temperature rises. If

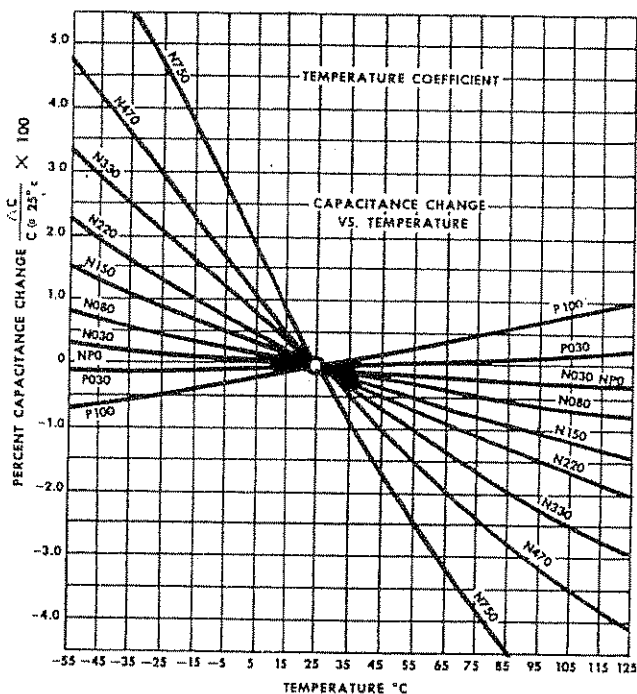

Fig. 34— Temperature change versus capacity change of P100 to N750 temperature compensated ceramic disc capacitors.

the tuning capacitor across the coil is a negative coefficient, then the net result will be a zero or very little change.

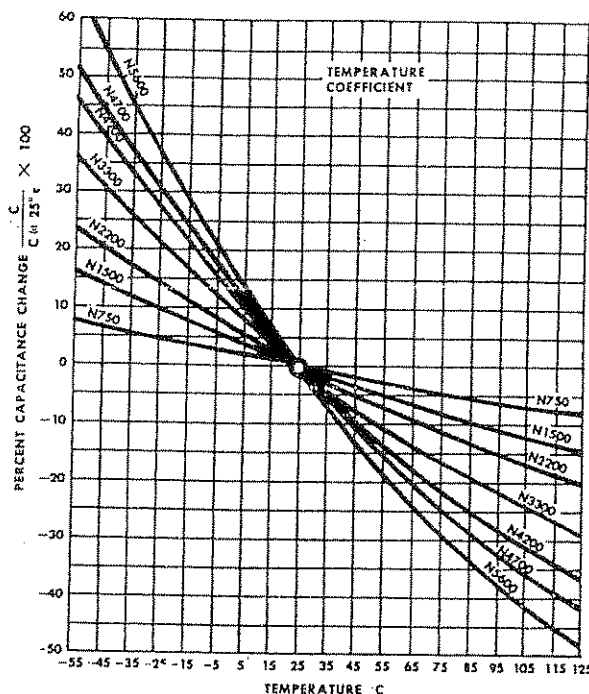

Fig. 35— Temperature change versus capacity change of N750 to N5600 temperature compensated ceramic disc capacitors.

General type ceramic discs are often marked with such letters as Z5U, Z5F, Y5V, X5V, and so forth. This indicates the type of temperature curve for the particular capacitor. Ceramic capacitors that are not NPO or rated with N or P type characteristics will have wider temperature variations and can vary both positive and negative with temperature changes. The Z5U probably has the greatest change and will only be found in non-critical applications such as B+ power supply decoupling. These type of capacitors should not be used in critical applications such as oscillator and timing circuits.

A ceramic capacitor marked GMV means that the value marked on the capacitor is the Guaranteed Minimum Value of capacity at room temperature. The actual value of the capacitor can be much higher. This type of capacitor is used in bypass applications where the actual value of capacity is not critical.

Ceramic capacitors have been the most popular capacitors in electronics because of the versatility of the different temperature coefficients and the cost. When replacing a ceramic disc capacitor, be sure to replace the defective capacitor with one having the same characteristics and voltage rating.

The aluminum electrolytic capacitor or "Lytic" is a very popular component. A large value capacity in a small case can be obtained quite easily. The aluminum lytic is used in power supply filtering, audio and video coupling and in bypass applications. Anywhere a large value of capacity is required with a small space availability, the lytic fits right in.

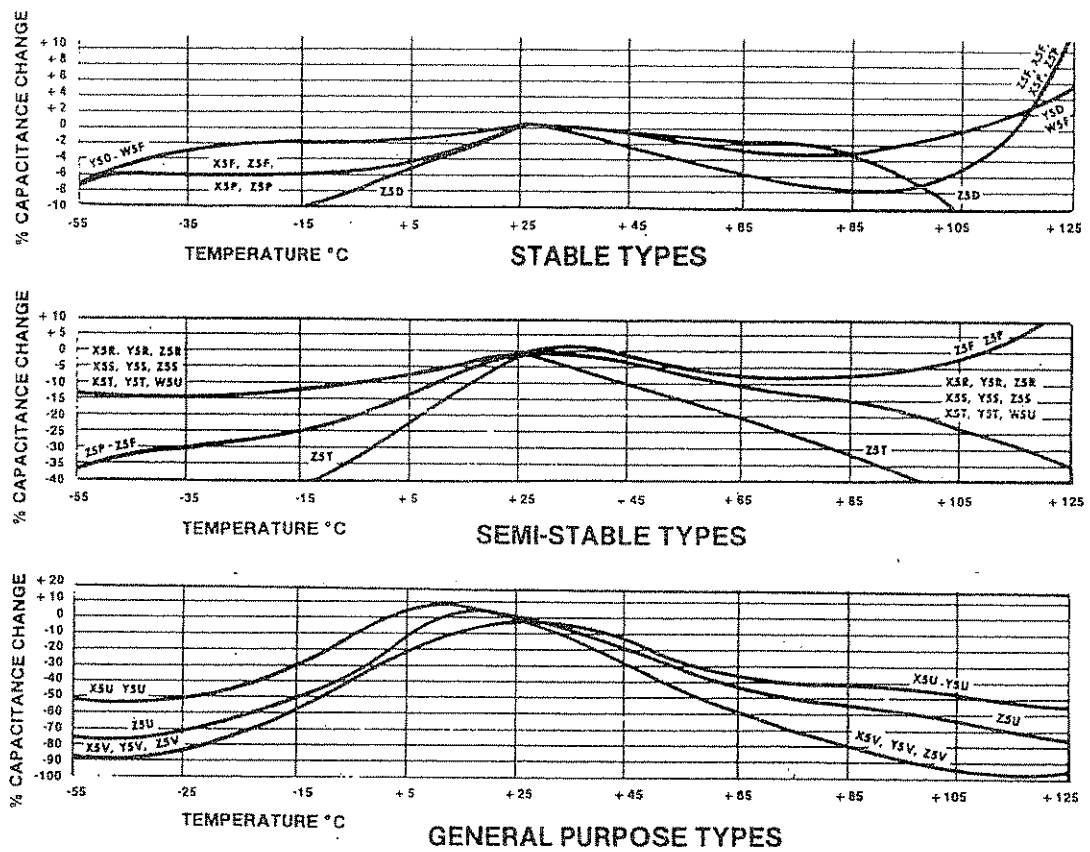

Fig. 36— Temperature change versus capacity change of non-temperature compensated ceramic disc capacitors.

The aluminum lytic is made by using a pure aluminum foil wound with a paper soaked in a liquid electrolyte. When a voltage is applied to the combination, a thin layer of oxide film forms on the pure aluminum forming the dielectric. As long as the electrolyte remains liquid, the capacitor is good or can be reformed after sitting for a while. When the electrolyte dries out the leakage goes up and the capacitor loses capacity. This can happen to aluminum lytics just sitting on the shelf. When an aluminum lytic starts drying out, the capacitor begins to show dielectric absorption.

The tantalum electrolytic capacitor is becoming very popular too. When it first appeared, the tantalum lytic was very high in cost compared to the aluminum lytic, but mass production technology has made the tantalum lytic comparable in cost with the aluminum lytic. While the leakage in the aluminum lytic is very high due to the nature of its construction, leakage in tantalum capacitors is very low. In addition, tantalum capacitors can be constructed with much tighter tolerances than the aluminum lytic. The tantalum is much smaller in size for the same capacity and working voltage than an aluminum lytic. Tantalum lytics have become very popular in timing circuits and for critical coupling where high capacity is required with low leakage. The capacity of the tantalum lytic is limited and for extremely large values of capacity for power supply filtering, the aluminum lytic is still the first choice.

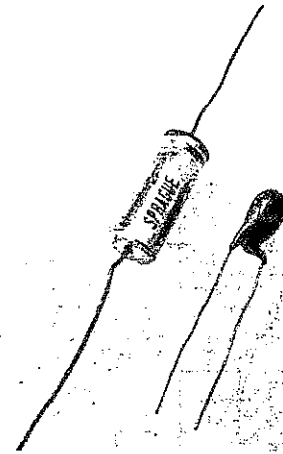

Fig. 37— The tantalum lytic on the right is much smaller in physical size than an aluminum lytic of similar capacity and working voltage.

There are many different types of capacitors, using different types of dielectrics, each with its own best capability. When replacing capacitors, it is best to replace with a capacitor having not only the same capacity and tolerance, but the same type of dielectric and temperature characteristics as well. This will insure of continued performance equal to the original.

The Z METER will measure leakage in the dielectric of a capacitor and will also show dielectric absorption.

The DC leakage is measured in two ranges with the value displayed on the digital readout in microamps.

Dielectric absorption will show up mostly in electrolytics as a changing capacitor value. If the capacitor is checked for leakage and then checked for value, the meter will show a lower value capacitor at first that slowly increases upward. This indicates that the electric dipoles in the dielectric are resisting the discharge of the capacitor and remaining polarized in the dielectric.

This dielectric absorption is sometimes called capacitor memory. It can also be referred to as battery action of a capacitor. What is actually happening is that the small voltage from the dielectric absorption is changing the RC charge curve and making the meter see a smaller value of capacitor. As the test continues, the dielectric charge or memory is slowly dissipated in the charge and recharge of the capacitor. This increases the length of the RC charge curve and allows the meter to read a higher and higher value capacitor. Dielectric absorption will not normally show up in film or ceramic capacitors, but if the Z METER test does indicate dielectric absorption the capacitor is a suspect. Dielectric absorption in these capacitors will generally be associated with a high leakage as well.

Capacitors can change value. On some multi-layer foil capacitors, poor welding or soldering of the foil to the leads can cause an open to one of the foils to develop due to stress of voltage or temperature. This can result in a loss of almost one-half of the capacitor's marked capacity. Ceramic disc capacitors can also change value due to fissures or cracks. Small fissures or cracks in the ceramic insulating material can be created by thermal stress from exposure to heat and cold. Sometimes very small fissures develop which do not effect the capacitor until much later. The crack will reduce the capacitor to a smaller value. Although the ceramic is still connected to the leads, the actual value of capacity could be a very small portion of the original value depending upon where the crack occurs. The Z METER will let you know what the value of the capacitor is regardless of its marked value.

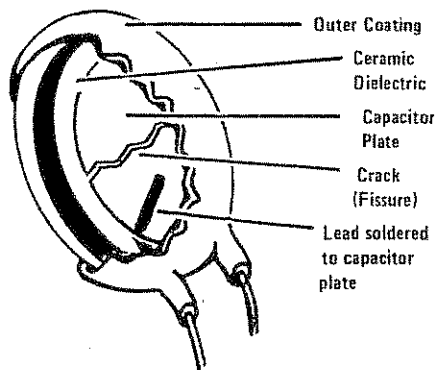

Fig. 38— A ceramic disc is made of a silver coated ceramic dielectric which is coated with a protective coating. Large cracks or fissures in the dielectric may develop which change the capacitance value.

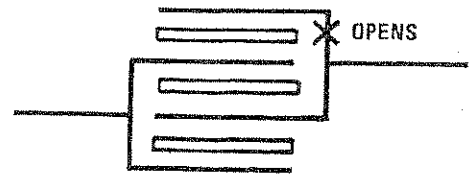
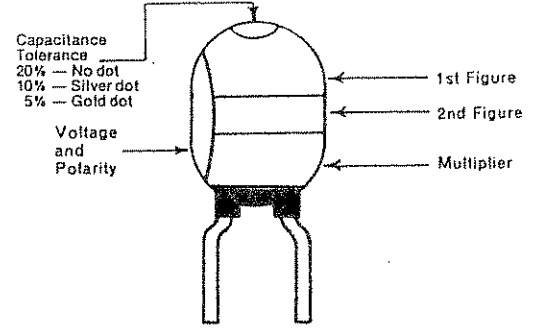

Fig. 39— A break in one of the foil connections to the lead of a multi-layer foil capacitor can reduce the capacity value.

Another problem which develops in capacitors is high Equivalent Series Resistance (ESR). All capacitors have a certain amount of ESR. Sources that contribute to ESR include lead resistance, dissipation in the dielectric material, and foil resistance. Larger values of capacitors, which have more foil, normally have larger values of ESR. Small, non electrolytic capacitors should have extremely small amounts of ESR. An electrolytic capacitor which has excessive ESR will develop internal heat which greatly reduces the life of the capacitor. In addition, ESR changes the impedance of the capacitor in circuit since it has the same effect as adding an external resistor in series with the component.

Dipped Tantalum Capacitors

Color	Rated Voltage	Capacitance in PicoFarads		Multiplier
		1st Figure	2nd Figure	
Black	4	0	0	—
Brown	6	1	1	—
Red	10	2	2	—
Orange	15	3	3	—
Yellow	20	4	4	10,000
Green	25	5	5	100,000
Blue	35	6	6	1,000,000
Violet	50	7	7	10,000,000
Gray	—	8	8	—
White	3	9	9	—



Ceramic Disc Capacitors

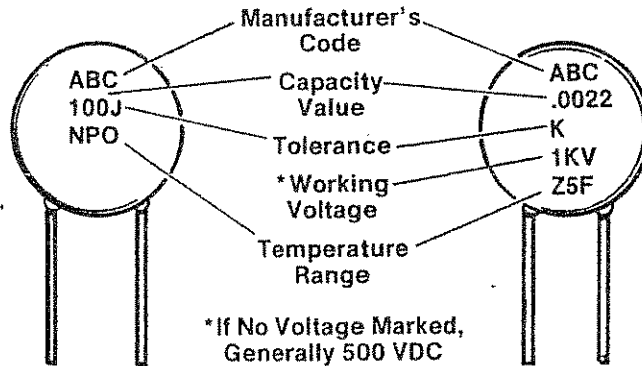

Typical Ceramic Disc Capacitor Markings

Low Temp.	Letter Symbol	High Temp.	Numerical Symbol	Max. Capac. Change Over Temp. Range	Letter Symbol
+10°C	Z	+45°C	2	+ 1.0%	A
-30°C	Y	+65°C	4	± 1.5%	B
-55°C	X	+85°C	5	± 1.1%	C
		+105°C	6	± 3.3%	D
		+125°C	7	± 4.7%	E
				± 7.5%	F
				± 10.0%	P
				± 15.0%	R
				± 22.0%	S
				+ 22%, -33%	T
				+ 22%, -56%	U
				+ 22%, -82%	V

1st & 2nd Fig. of Capacitance	Multiplier	Numerical Symbol	Tolerance on Capacitance	Letter Symbol
	1	0	± 5%	J
	10	1		
	100	2		
	1,000	3		
	10,000	4		
	100,000	5	± 10%	K
			± 20%	M
			+ 100%, -0%	P
			+ 80%, -20%	Z
	.01	8		
	.1	9		

Temperature Range Identification of Ceramic Disc Capacitors

Capacity Value and Tolerance of Ceramic Disc Capacitors

Film Type Capacitors

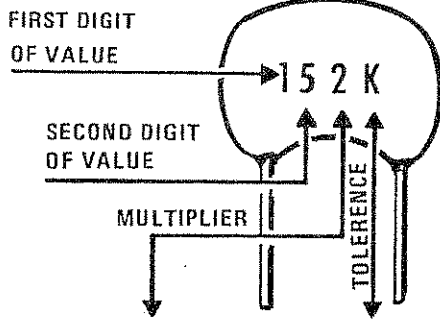

MULTIPLIER		TOLERANCE OF CAPACITOR		
For the Number	Multiplier	Letter	10 pF or Less	Over 10 pF
0	1	B	± 0.1 pF	
1	10	C	$\pm .25$ pF	
2	100	D	± 0.5 pF	
3	1,000	F	± 1.0 pF	$\pm 1\%$
4	10,000	G	± 2.0 pF	$\pm 2\%$
5	100,000	H		$\pm 3\%$
8	0.01	J		$\pm 5\%$
		K		$\pm 10\%$
9	0.1	M		$\pm 20\%$

EXAMPLES:

152K = $15 \times 100 = 1500$ pF or $.0015$ uF, $\pm 10\%$
 759J = $75 \times 0.1 = 7.5$ pF, $\pm 5\%$

NOTE: The letter "R" may be used at times to signify a decimal point; as in: 2R2 = 2.2 (pF or uF).

Ceramic Feed Through Capacitors

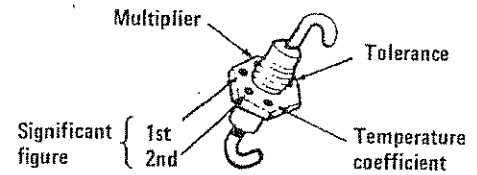

Color	Significant Figure	Multiplier	Tolerance 10 pF or Less	Tolerance Over 10 pF	Temperature Coefficient
Black	0	1	2 pF	20%	0
Brown	1	10	0.1 pF	1%	N30
Red	2	100	—	2%	N60
Orange	3	1,000	—	2.5%	N150
Yellow	4	10,000	—	—	N220
Green	5	—	5 pF	5%	N330
Blue	6	—	—	—	N470
Violet	7	—	—	—	N750
Gray	8	0.001	0.025 pF	—	P30
White	9	0.1	1 pF	10%	+ 120 to -750 (RETMA) + 500 to -330 (JAN)
Gold	—	—	—	—	P100
Silver	—	—	—	—	Bypass or coupling

Postage Stamp Mica Capacitors

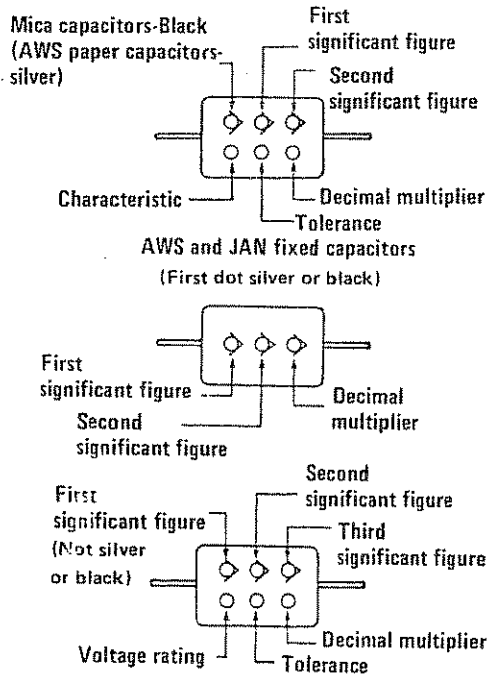

Color	Significant Figure	Multiplier	Tolerance (%)	Voltage Rating
Black	0	1	—	—
Brown	1	10	1	100
Red	2	100	2	200
Orange	3	1,000	3	300
Yellow	4	10,000	4	400
Green	5	100,000	5	500
Blue	6	1,000,000	6	600
Violet	7	10,000,000	7	700
Gray	8	100,000,000	8	800
White	9	1,000,000,000	9	900
Gold	—	0.1	5	1000
Silver	—	0.01	10	2000
No color	—	—	20	500

Standard Button Mica

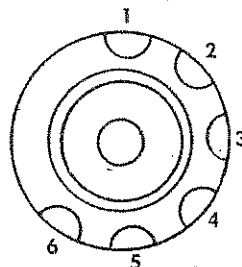

1st DOT	2nd and 3rd DOTS		4th DOT	5th DOT		6th DOT
Identifier	Capacitance in pF		Multiplier	Capacitance Tolerance		Temp. Characteristic
	Color	1st & 2nd Sig. Figs.		Percent	Letter Symbol	
Black	Black	0	1	± 20%	F	
	Brown	1	10	± 1%	F	
<i>NOTE: Identifier is omitted if capacitance must be specified to three significant figures.</i>	Red	2	100	± 2% or ± 1 pF	G or B	
	Orange	3	1000	± 3%	H	
	Yellow	4				+ 100
	Green	5				
	Blue	6				
	Violet	7				-20 PPM/°C above 50 pF
	Gray	8		0.1		
White	9			± 5%	J	
Silver				± 10%	K	

Radial or Axial Lead Ceramic Capacitors (6 Dot or Band System)

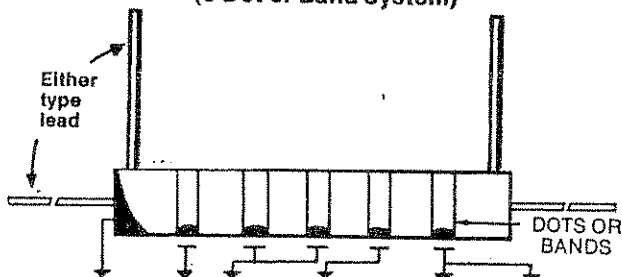

5 Dot or Band Ceramic Capacitors (one wide band)

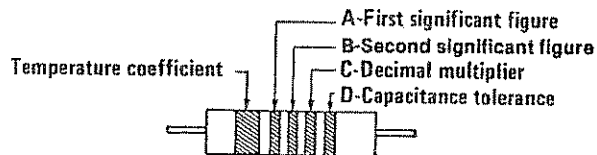

Fixed ceramic capacitors, 5 dot or band system

Temp. Coefficient	Capacitance				Nominal Capacitance Tolerance			
	T.C.	1st Color	2nd Color	1st and 2nd Sig. Fig.	Multiplier	Color	10 pF or Less	Over 10 pF
P100	Red	Violet	0	1	Black	± 2.0 pF	± 20%	Black
P030	Green	Blue	1	10	Brown	± 0.1 pF	± 1%	Brown
NP0	Black		2	100	Red		± 2%	Red
N030	Brown		3	1,000	Orange		± 3%	Orange
N080	Red		4	10,000	Yellow		+ 100% - 0%	Yellow
N150	Orange		5		Green	± 0.5 pF	± 5%	Green
N220	Yellow		6		Blue			Blue
N330	Green		7		Violet			Violet
N470	Blue		8	01	Gray	± 0.25 pF	+ 80% - 20%	Gray
N750	Violet		9	1	White	± 1.0 pF	± 10%	White
N1500	Orange	Orange						
N2200	Yellow	Orange						
N3300	Green	Orange						
N4200	Green	Green						
N4700	Blue	Orange						
N5600	Green	Black						
N330 ± 500	White							
N750 ± 1000	Gray							
N2300 ± 2500	Gray	Black						

Color Code for Ceramic Capacitors

Color	1st & 2nd Significant Figure	Multiplier	Capacitance Tolerance		Temp. Coeff.
			Over 10 pF	10 pF or Less	
Black	0	1	± 20%	2.0 pF	0
Brown	1	10	± 1%		N30
Red	2	100	± 2%		N80
Orange	3	1000			N150
Yellow	4				N220
Green	5				N330
Blue	6		± 5%	0.5 pF	N470
Violet	7				N750
Gray	8	0.01		0.25 pF	P 30
White	9	0.1	± 10%	1.0 pF	P500

Notes

GLOSSARY

Aging - operating a component or instrument at controlled conditions for time and temperature to screen out weak or defective units and, at the same time, stabilize the good units.

Anode - the positive electrode of a capacitor.

Capacitance - the measure of the size of a capacitor. Usually expressed in microfarads and the picofarads. Determined by the size of the plates, and the dielectric material.

Capacitive reactance - the opposition to the flow of a pulsating DC voltage or AC voltage. Measured in ohms.

Capacitor - an electronic component consisting of two metal plates separated by a dielectric. Can store and release electrical energy, block the flow of DC current or filter out or bypass AC currents.

Cathode - the negative electrode of a capacitor.

Charge - the quantity of electrical energy stored or held in a capacitor.

Clearing - the removal of a flaw or weak spot in the dielectric of a metalized capacitor. The stored energy in the capacitor vaporizes the material in the immediate vicinity of the flaw. Also called self-healing or self-clearing.

COG - same as NPO. Very small capacity change for large temperature changes.

Coil - an inductor wound in a spiral or circular fashion. Can be wound on a form or without a form such as an air coil.

CV product - the capacitance of a capacitor multiplied by its working voltage. Used when determining the leakage allowable in electrolytic capacitors. The CV product is also equal to the charge that a capacitor can store at its maximum voltage.

Dielectric - the insulating or non-conducting material between the plates of a capacitor. Typical dielectrics include air, impregnated paper, plastic films, oil, mica and ceramic.

Dielectric absorption - the measure of the reluctance of a capacitor to completely discharge. The charge that remains after a determined discharge time is expressed in a percentage of the original charge. Can also be called "Capacitor Memory" or "Battery Action."

Dielectric constant - the ratio of capacitance between a capacitor having a dry air dielectric and the given material. A figure for determining the efficiency of a given dielectric material. The larger the dielectric constant, the greater the capacity with a given size plate.

Disc capacitor - a small single layer ceramic capacitor consisting of disc of ceramic insulator with silver deposited on both sides as the plate. The ceramic material can be of different compositions to give different temperature curves to the capacitor.

Dissipation factor (DF) - the ratio of the effective series resistance of a capacitor compared to its reactance at a given frequency, generally give in percent.

Electrolyte - a current conducting liquid or solid between the plates or electrodes of a capacitor with at least one of the plates having an oxide or dielectric film.

Electrolytic capacitor (aluminum) a capacitor consisting of two conducting electrodes of pure aluminum, the anode having an oxide film which acts as the dielectric. The electrolyte separates the plates.

Equivalent series resistance (ESR) used in capacitor calculations. All internal series resistance of a capacitor are lumped into one resistor and treated as one resistor at one point in the capacitor.

Farad - the measure or unit of capacity. Too large for electronic use and is generally measured in microfarads or picofarads.

Fissures - cracks in the ceramic dielectric material of disc capacitor, most often caused by thermal shock. Some small fissures may not cause failure for a period of time until exposed to great thermal shock or mechanical vibration for a period of time.

Fixed capacitor - a capacitor designed with a specific value of capacitance that cannot be change.

Gimmick - a capacitor formed by two wires or other conducting materials twisted together or brought into close proximity of each other.

GMV - Guaranteed Minimum Value. The smallest value this ceramic capacitor will have. Its value could be much higher.

Henry - The unit of the measure of inductance. Also expressed in microhenry and millihenry.

Inductor - a device consisting of one or more windings with or without a magnetic material core or introducing inductance into a circuit.

Inductance - the property of a coil or transformer which induces an electromagnetic force in that circuit or a neighboring circuit upon application of an alternating current.

Inductive reactance - the opposition of an inductor to an alternating or pulsating current.

Impedance - the total opposition of a circuit to the flow of an alternating or pulsating current.

Insulation resistance - the ratio of the DC working voltage and the resulting leakage current through the dielectric. Generally a minimum value is specified, usually in the several thousand megohms range.

Iron Core - the central portion of a coil or transformer. Can be a powdered iron core as in small coils used in RF to the large iron sheets used in power transformers.

Leakage current - stray direct current flowing through the dielectric or around it in a capacitor when a voltage is applied to its terminals.

Metalized capacitor - one in which a thin film of metal has been vacuum plated on the dielectric. When a breakdown occurs, the metal film around it immediately burns away. Sometimes called a self-healing capacitor.

Monolithic ceramic capacitor - a small capacitor made up of several layers of ceramic dielectric separated by precious metal electrodes.

Mutual inductance - the common property of two inductors whereby the induced voltage from one is induced into the other. The magnitude is dependent upon the spacing.

NPO - an ultra stable temperature coefficient in a ceramic disc capacitor. Derived from "negative-positive-zero". Does not change capacity with temperature changes.

Padder - a high capacity variable capacitor placed in series with a fixed capacitor to vary the total capacity of the circuit by a small amount.

Power factor - the ratio of the effective resistance of a capacitor to its impedance.

Reactance - the opposition of a capacitor or inductor to the flow of an AC current or a pulsating DC current.

Solid tantalum capacitor - an electrolytic capacitor with a solid tantalum electrolyte instead of a liquid. Also called a solid electrolyte tantalum capacitor.

Surge voltage - the maximum safe voltage in peaks to which a capacitor can be subjected to and remain within the operating specifications. This is not the working voltage of the capacitor.

Temperature coefficient (TC) - the changes in capacity per degree change in temperature. It can be positive, negative, or zero. Expressed in parts per million per degree centigrade for linear types. For non-linear types, it is expressed as a percent of room temperature.

Time constant - the number of seconds required for a capacitor to reach 63.2% of its full charge after a voltage is applied. The time constant is the capacity in farads times the resistance in ohms is equal to seconds ($T=RC$).

Trimmer - a low value variable capacitor placed in parallel with a fixed capacitor of higher value so that the total capacity of the circuit may be adjusted to a given value.

Variable capacitor - a capacitor that can be changed in value by varying the distance between the plates or the useful area of its plates.

Voltage rating - see working voltage.

Wet (slug) tantalum capacitor - an electrolytic capacitor having a liquid cathode.

Working voltage - the maximum DC voltage that can be applied to a capacitor for continuous operation at the maximum rated temperature.

Notes

SERVICE & WARRANTY

Warranty

Your Sencore instrument has been built to the highest quality standards in the industry. Each unit has been tested, aged under power for at least 24 hours, and then retested on every function and range to insure it met all published specifications after aging. Your instrument is fully protected with a 1 year warranty and Sencore's exclusive 100% Made Right Lifetime Guarantee in the unlikely event a manufacturing defect is missed by these tests. Details are covered in the separate booklet. Read this booklet thoroughly, and keep it in a safe place so you can review it if questions arise later.

Service

The Sencore Factory Service Department provides all in or out-of-warranty service and complete recalibration services for Sencore instruments. NO LOCAL SERVICE CENTERS ARE AUTHORIZED TO REPAIR SENCORE INSTRUMENTS. Factory service assures you of the highest quality work, the latest circuit improvements, and the fastest turnaround time possible because every technician specializes in Sencore instruments. Sencore's Service Department can usually repair your instrument and return it to you faster than a local facility servicing many brands of instruments, even when shipping time is included.

YOU DO NOT NEED AUTHORIZATION TO RETURN AN INSTRUMENT TO SENCORE FOR SERVICE. Be sure you include your name and address along with a description of the symptoms if it should ever be necessary to return your instrument. Ship your instrument by United Parcel Service or air freight if possible. Use parcel post only when absolutely necessary.

BE SURE THE INSTRUMENT IS PROPERLY PACKED. Use the original shipping carton and all packing inserts whenever possible. If the original packing material is not available, make certain the unit is properly packed in a sturdy box with shock-absorbing material on all sides. Sencore suggests insuring the instrument for its full value in case it is lost or damaged in shipment.

A separate schematic and parts list is included if you wish to repair your own instrument. Parts may be ordered directly from the Factory Service Department. Any parts not shown in the parts list may be ordered by description. Maintenance instructions and circuit descriptions may be ordered from the Service Parts Department.

We reserve the right to examine defective components before an in-warranty replacement is issued.

SENCORE FACTORY SERVICE
3200 Sencore Drive
Sioux Falls, SD 57107
In SD call collect (605) 339-0100
In U.S. call: 1-800-SENCORE
In Canada call: 1-800-851-8866

Fill in for your records:

Date Purchased: _____

Run Number _____

(NOTE: Please refer to the run number if it is necessary to call the Service Department. The run number may be updated when the unit has been returned for service.)



WATS Free 1-800-SENCORE In Canada 1-800-851-8866

SENCORE *innovatively designed*

3200 Sencore Drive *with your time in mind.*

Sioux Falls, SD 57107

Call Collect 605-339-0100 In SD